

Surgical Technique



Acumed® is a global leader of innovative orthopaedic and medical solutions.



We are dedicated to developing products, service methods, and approaches that improve patient care.



Acumed Anatomic Radial Head System

The Acumed Anatomic Radial Head Prosthesis is designed to provide a precise anatomical implant to replace the patient's native radial head. Many innovative design features are incorporated into the implant heads and stems, as well as the instrumentation to facilitate the surgical technique.

The Anatomic Radial Head System is a comprehensive solution for radial head fractures. The Acutrak 2® Mini and Micro Instruments are included in the base of the tray, as well as the Radial Head Plating System.

With the Anatomic Radial Head System, the surgeon is equipped with the tools needed to properly restore the patient's anatomy in a radial head replacement surgery.

Designed in conjunction with Shawn W. O'Driscoll, MD, PhD the Acumed Anatomic Radial Head System provides a comprehensive solution for radial head replacement.

	Definition
Warning	Indicates critical information about a potential serious outcome to the patient or the user.
Caution	Indicates instructions that must be followed in order to ensure the proper use of the device.
Note	Indicates information requiring special attention.



Table of Contents

System Features	2
Instrument Overview	6
Surgical Technique Overview	8
Surgical Technique	10
Anatomic Radial Head System	10
Ordering Information	16
References	23

System Features

Radial Head Implants

The dish is offset 1 mm laterally to mimic the patient's anatomy. The dish depth remains static at 2 mm amongst all implant diameters, and a net head height of 10 mm was found to most closely replicate native anatomy^{1,2,3}



Head Implants: 20–28 mm
(TR-H200X-S–TR-H280X-S)

System Features [continued]

Standard Stem Implants

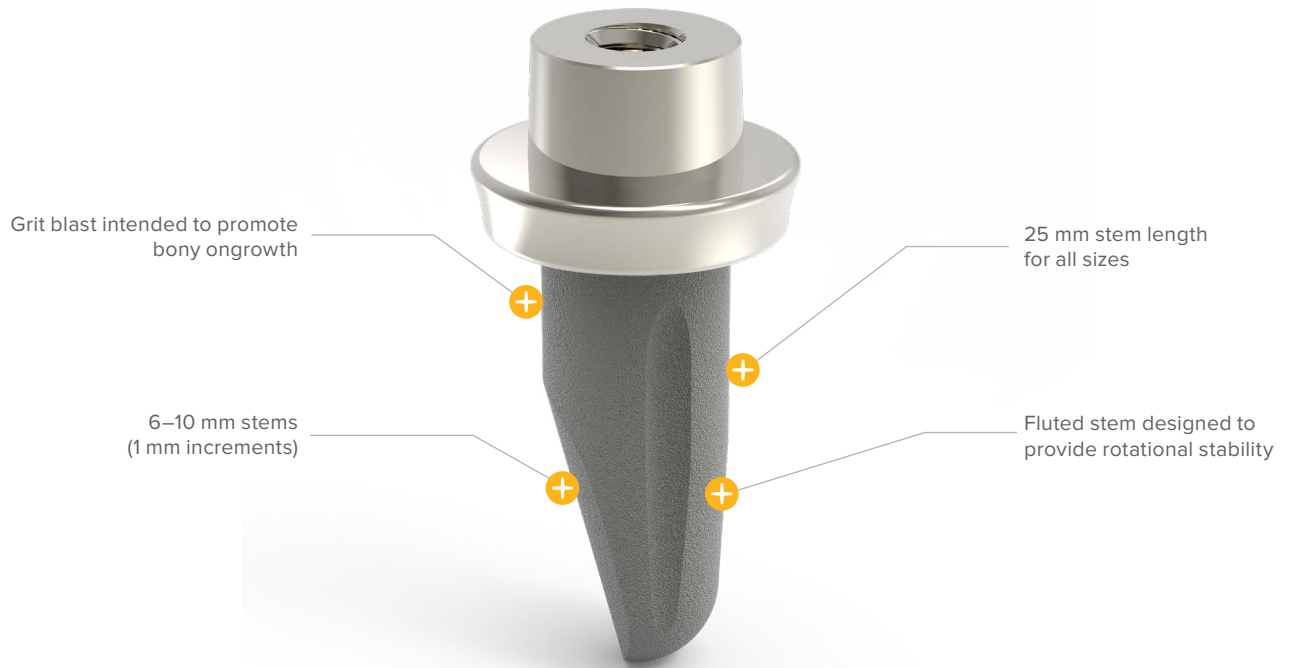

	Diameters				
	6 mm	7 mm	8 mm	9 mm	10 mm
Heights					
+0 mm					
+2mm					
+4 mm					
+8 mm					

Standard Stem Implants: 6–10 mm diameters
(TR-SXXXX-S)

System Features [continued]

Instrumentation

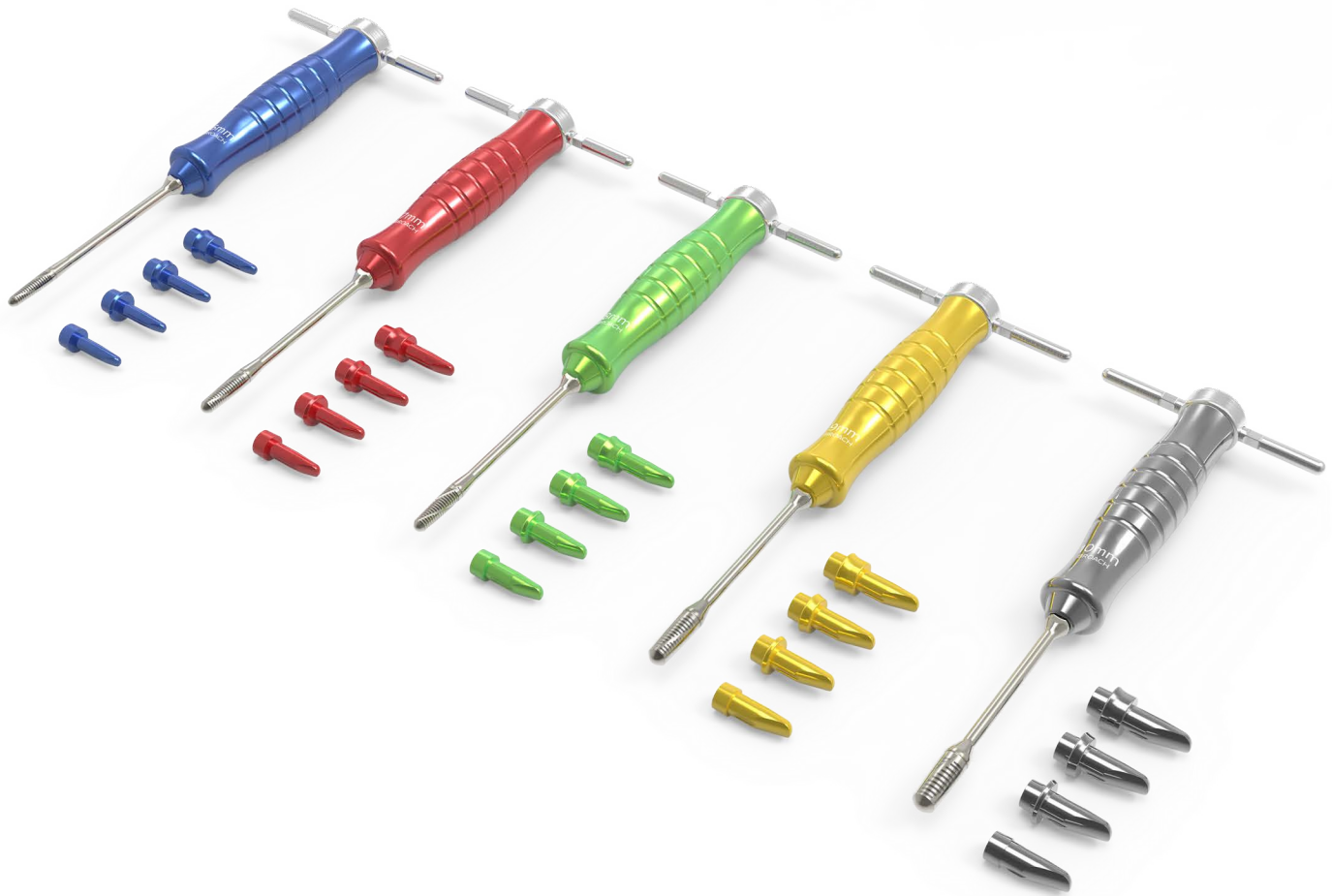

Broaches

The innovative broaches in the Anatomic Radial Head System allow the surgeon to create a precise opening in the radial canal for proper insertion of the implant. The broaches enter the radial canal in a straight direction and are less likely to broach the canal at an angle, thus preventing improper implant placement. Spiral flutes on the broach are designed to displace bone during broaching. The implant stem is 0.5 mm larger than the broach diameter. The trial stem diameter is 0.5 mm smaller than the broach diameter to allow for ease of trial insertion and removal.

A mallet should be used to insert the broach. Side pegs are provided for removal with a mallet and also provide a T-handle to ease broach insertion and extraction. Furthermore, the broaches are color-coded for ease of trial implant selection.



System Features [continued]

Instrumentation

Collar reamers are included in the system to create a perpendicular neck surface for the stem, facilitating accurate stem placement.

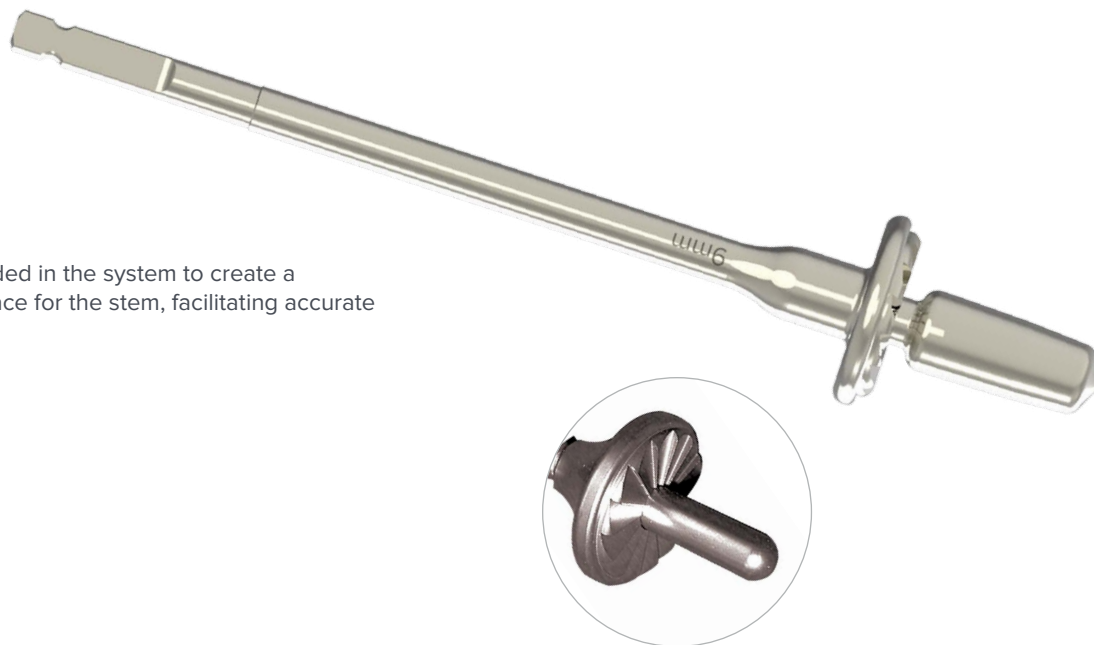

A unique guide allows the surgeon to determine proper collar height. A sizing gauge is placed in the radial canal and then ratcheted proximally with the collar sizing gauge. The measurement corresponds to proper collar height for accurate restoration of radial length.

Instrument Overview



6.0 mm Stem Gauge Assembly
(TR-TGA06)



Height Gauge
(TR-TG02)



Trial Gauge
(TR-TG01)



Quick Release T-Handle
(MS-T1212)



Stem Removal Tool
(TR-MS30)



Impactor Base
(TR-MS03)



5.5 mm Quick Release Awl
(TR-0206)



Large Cannulated Quick Release Driver Handle
(MS-3200)



6 mm Broach Assembly
(TR-BRA06)



7 mm Broach Assembly
(TR-BRA07)



8 mm Broach Assembly
(TR-BRA08)



9 mm Broach Assembly
(TR-BRA09)



10 mm Broach Assembly
(TR-BRA10)



AT2 Screw Sizer
(AT2-SMCZ)



.035" x 5.75" ST Guide Wire
(WS-0906ST)



.035 Diameter, Parallel Wire Guide Assembly
(AT2-3500)

Instrument Overview [continued]



Head Impactor
(TR-MS05)



Micro Acutrak 2® Drill
(AT2-1509)



Micro Acutrak 2® Drill, Long
(80-0100)



1.5 mm Cannulated Quick Release Driver Tip
(HT-0915)



2.0 mm Cannulated Quick Release Driver Tip
(HT-1120)



Mini Acutrak 2® Drill
(AT2M-1813)



Mini Acutrak 2® Drill, Long
(AT2M-L1813)



.045 Diameter, Parallel Wire Guide Assembly
(AT2-4500)



.045" x 6" ST Guide Wire
(WS-1106ST)



6 mm Collar Reamer
(TR-CRA06)



7 mm Collar Reamer
(TR-CRA07)



8 mm Collar Reamer
(TR-CRA08)



9 mm Collar Reamer
(TR-CRA09)



10 mm Collar Reamer
(TR-CRA10)

Surgical Technique Overview

Incision and Dissection

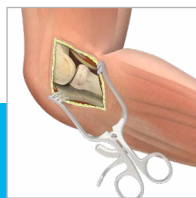

Radial Head Resection

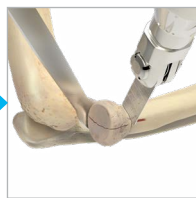

Determine Stem Diameter



Ream with Collar Reamer



Determine Head Diameter

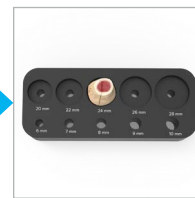

Anatomic Radial Head System Surgical Technique

Assemble Head and Stem Gauge



Determine Collar Height



Select Trial Implants and Assemble

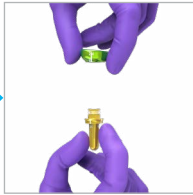

Trial Implant Insertion



Implant Assembly



Implant Insertion



Anatomic Radial Head System Surgical Technique

Figure 1

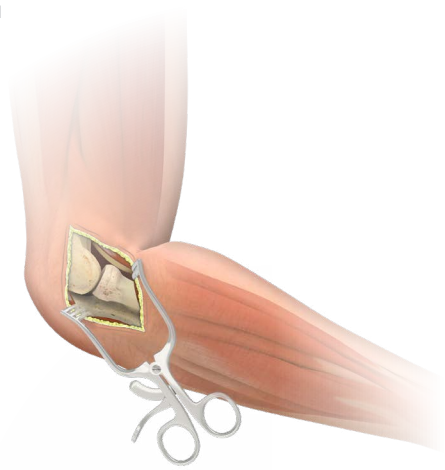

1 Incision and Dissection

While there are many acceptable exposure methods, the Kaplan interval in a line from the lateral epicondyle toward Lister's tubercle, with the forearm in neutral rotation, permits the collateral ligament to be left intact. In fracture dislocations, the exposure is through the traumatic opening in the ligament complex. Proximally, the extensor carpi radialis longus (ECRL) origin is released with the anterior capsule to permit direct access to the front of the radial head.

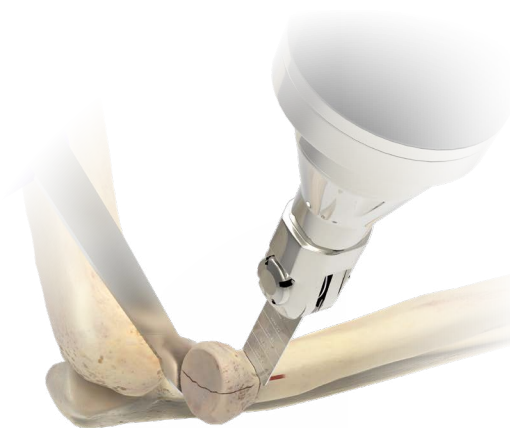

Figure 2

2 Radial Head Resection

Template the radial head prior to surgery to determine the appropriate level of resection. Resect the radial head with a microsagittal saw as close to the surgical neck as possible. A maximum length of 17 mm of the radius can be replaced. This 17 mm includes the radius length reamed with the collar reamer in Step 4.

Anatomic Radial Head System Surgical Technique [continued]

3 Determine Stem Diameter

Use the 5.5 mm Quick Release Awl (TR-0206) to initially enter the canal. Starting with the smallest Broach (6 mm, TR-BRA06), prepare the canal for the stem. Use sequentially larger broaches until a tight fit is achieved with the broach. Tap on the back end of the broach with a mallet. There is a groove on the broach just above the cutting flutes that indicates when to stop.

Note: The broaches are 0.5 mm undersized from the implants to ensure a tight press fit.

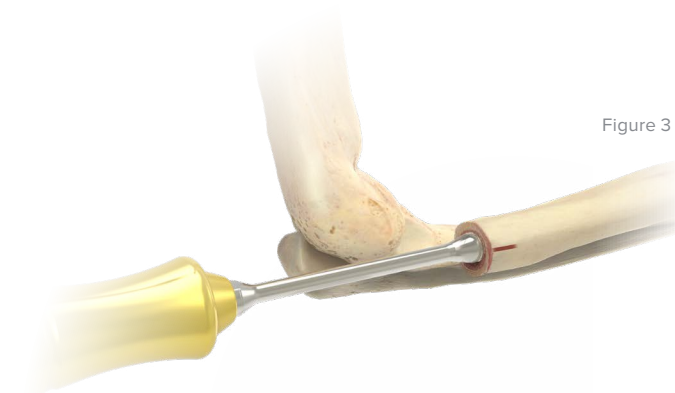

Figure 3

4 Ream with Collar Reamer

Select the Collar Reamer (TR-CRAXX) that matches the stem diameter determined by the broach in the previous step. Under power or by hand, ream to create a surface where at least 60% of the radial shaft is in contact with the reamer. To ream by hand, attach the collar reamer to the Quick Release T-Handle (MS-T1212). Do not over-ream the radial shaft; removing too much bone will prevent the radial head from articulating properly with the capitellum.

Caution: Avoid fracturing the radial collar, which can occur if the reamer catches on irregular bone in the fracture surface.

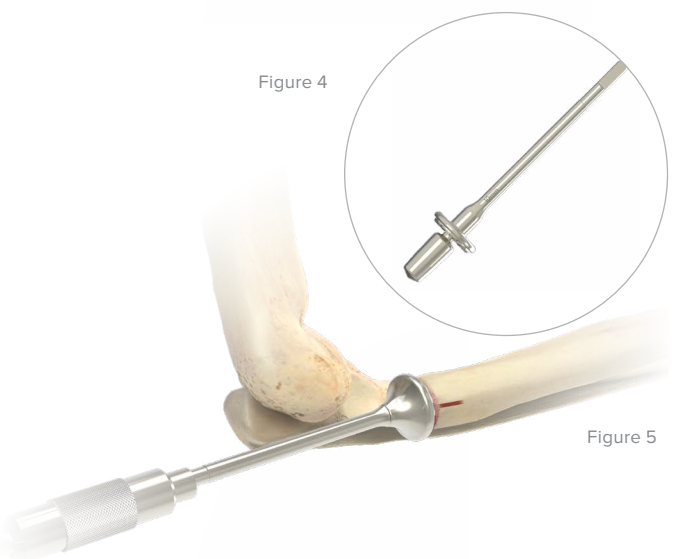

Figure 4

Figure 5

5 Determine Head Diameter

Determine the head diameter by placing the resected head into the sizing pockets on the Impactor Base (TR-MS03). If between sizes, select the smaller diameter.



Figure 6



5.5 mm Quick Release Awl (TR-0206)



6 mm Broach (TR-BRA06)



Collar Reamer (TR-CRAXX)



Quick Release T-Handle (MS-T1212)



Impactor Base (TR-MS03)

Anatomic Radial Head System Surgical Technique [continued]

Figure 7

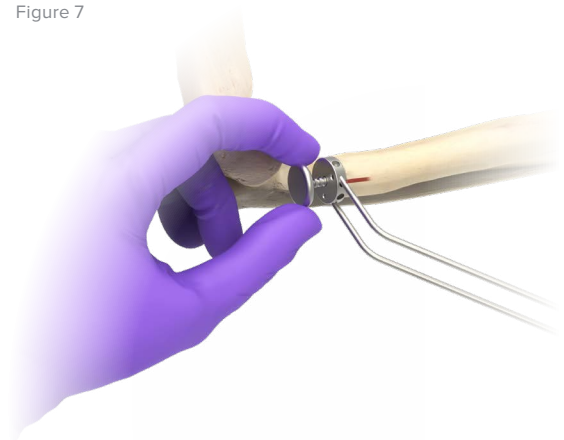

6 Assemble Head and Stem Gauge

Assemble the Height Gauge (TR-TG02) and 6.0 mm Stem Gauge Assembly (TR-TGA06). The Height Gauge needs to be completely compressed.

Figure 8



7 Determine Collar Height

Insert the 6.0 mm Stem Gauge Assembly (TR-TGA06) into the bone canal. Starting with the +0 end of the Trial Gauge (TR-TG01), sequentially increase the height by inserting the end of the gauge under the head of the assembly, until the head reaches the capitellum. It is critical that the coronoid contacts the trochlea during this process. Separation of the coronoid from the trochlea is an indicator that the collar is too large. The number on the Trial Gauge (+0, 2, 4, 8 mm) will correspond to the collar height on the stem.

Warning: If between sizes, select the shorter height. Implantation of components that are too large may result in a joint that is "overstuffed."



Height Gauge
(TR-TG02)



6.0 mm Stem
Gauge Assembly
(TR-TGA06)



Trial Gauge
(TR-TG01)

Anatomic Radial Head System Surgical Technique [continued]

8 Select Trial Implants and Assemble

After selecting the Trial Head (TR-THXXX) and Trial Stem (TR-TSXX or TR-TSXXX), align the laser marks on the head and stem and assemble using hand pressure. The stem laser mark is indicated for Left and Right for proper orientation. If the trial head and stem are difficult to connect, apply saline solution prior to connecting.

Note: Left-specific trials are blue and right-specific trials are green.

Figure 9

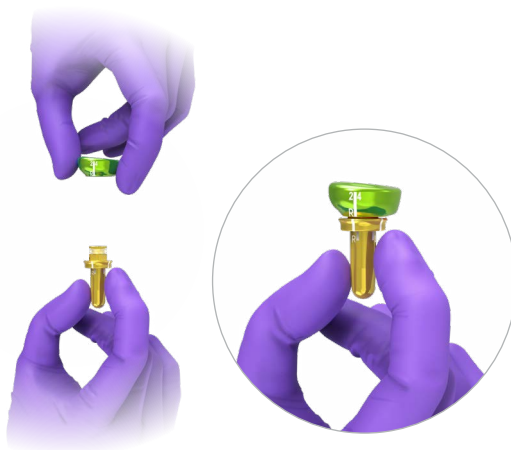

Figure 10

9 Trial Implant Insertion

Insert the assembled trial implant into the radius. Ensure that the laser marks on the head and stem are aligned with the lateral aspect of the radius when the forearm is in neutral position. Lister's tubercle may also be used as a landmark for laser mark orientation. Check for proper articulation with the capitellum and the coronoid. The coronoid needs to be in contact with the trochlea to ensure proper positioning of the trial.

Warning: Trial components are NOT designed to be implanted.

Note: The trial stem diameters are 0.5 mm undersized from the broaches for ease of insertion.



Figure 11

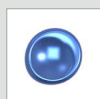

Trial Head
(TR-THXXX)



Trial Stem
(TR-TSXX or
TR-TSXXX)

Anatomic Radial Head System Surgical Technique [continued]

Figure 12



Figure 13



Figure 14



Figure 15



10 Implant Assembly

After determining the correct size head and stem with the trials, place the Stem Implant (TR-SXXXX-S) into the appropriate-size hole in the Impactor Base (TR-MS03). Align the laser marks and impact the Head Implant (TR-H2XXX-S) and stem, then lock the Morse taper using the Head Impactor (TR-MS05) and a mallet.

11a Implant Insertion

Insert the assembled implant into the radius using the Head Impactor (TR-MS05) and a mallet. Ensure that the laser mark on the head is aligned with the lateral aspect of the radius when the forearm is in neutral position. Lister's tubercle may also be used as a landmark for laser mark orientation. A Stem Removal Tool (TR-MS30) is available in the system if needed.

11b Alternative Implant Insertion With Bone Cement

If desired, the prosthesis may be cemented into position. The same anatomic landmarks as previously described are used to ensure proper alignment. Select an implant that is one size smaller than the reamer to allow for a 0.5 mm cement mantle. A higher viscosity cement should be used to allow precoating of the stem prior to implantation. The precoat is applied while the cement is malleable. Prior to stem insertion, malleable cement may be inserted into the radial canal. Insert into its anatomic position and hold the elbow in a flexed position while the cement hardens. Check for cement extrusion around the radial neck and remove if present. Once the cement is firm and cooled (per the cement IFU), the elbow can be moved freely as needed.

Optionally, a cement restrictor (not available through Acumed) may be inserted approximately 1 cm distal to the tip of the implant to prevent extravasation down the intramedullary canal of the radius and to improve the cement mantle.



Stem Implant (TR-SXXXX-S)



Impactor Base (TR-MS03)



Head Implant (TR-H2XXX-S)



Head Impactor (TR-MS05)



Stem Removal Tool (TR-MS30)

Anatomic Radial Head System Surgical Technique [continued]

12 Postoperative Protocol

Note: The following protocol may be replaced with an alternative protocol at the performing surgeon's discretion.

Postoperative management is determined by the overall management of the elbow and limb, more so than specifically the radial head. For isolated fractures of the radial head and neck without ligament injury, early motion is commenced in flexion and extension as well as pronation and supination. This usually begins within the first few days after surgery.



Figure 16

Ordering Information

Tray Components					
Instrumentation		Trial Stem Implants			
1	6.0 Stem Gauge Assembly	TR-TGA06	22	6 mm x 0 mm Trial Stem	TR-TS60
2	Height Gauge	TR-TG02	23	6 mm x 2 mm Trial Stem	TR-TS62
3	Trial Gauge	TR-TG01	24	6 mm x 4 mm Trial Stem	TR-TS64
4	Quick Release T-Handle	MS-T1212	25	6 mm x 8 mm Trial Stem	TR-TS68
5	Stem Removal Tool	TR-MS30	26	7 mm x 0 mm Trial Stem	TR-TS70
6	Impactor Base	TR-MS03	27	7 mm x 2 mm Trial Stem	TR-TS72
7	6 mm Collar Reamer	TR-CRA06	28	7 mm x 4 mm Trial Stem	TR-TS74
8	7 mm Collar Reamer	TR-CRA07	29	7 mm x 8 mm Trial Stem	TR-TS78
9	8 mm Collar Reamer	TR-CRA08	30	8 mm x 0 mm Trial Stem	TR-TS80
10	9 mm Collar Reamer	TR-CRA09	31	8 mm x 2 mm Trial Stem	TR-TS82
11	10 mm Collar Reamer	TR-CRA10	32	8 mm x 4 mm Trial Stem	TR-TS84
Trial Head Implants		33	8 mm x 8 mm Trial Stem	TR-TS88	
12	20 mm Trial Head, Left	TR-TH20L	34	9 mm x 0 mm Trial Stem	TR-TS90
13	20 mm Trial Head, Right	TR-TH20R	35	9 mm x 2 mm Trial Stem	TR-TS92
14	22 mm Trial Head, Left	TR-TH22L	36	9 mm x 4 mm Trial Stem	TR-TS94
15	22 mm Trial Head, Right	TR-TH22R	37	9 mm x 8 mm Trial Stem	TR-TS98
16	24 mm Trial Head, Left	TR-TH24L	38	10 mm x 0 mm Trial Stem	TR-TS100
17	24 mm Trial Head, Right	TR-TH24R	39	10 mm x 2 mm Trial Stem	TR-TS102
18	26 mm Trial Head, Left	TR-TH26L	40	10 mm x 4 mm Trial Stem	TR-TS104
19	26 mm Trial Head, Right	TR-TH26R	41	10 mm x 8 mm Trial Stem	TR-TS108
20	28 mm Trial Head, Left	TR-TH28L			
21	28 mm Trial Head, Right	TR-TH28R			

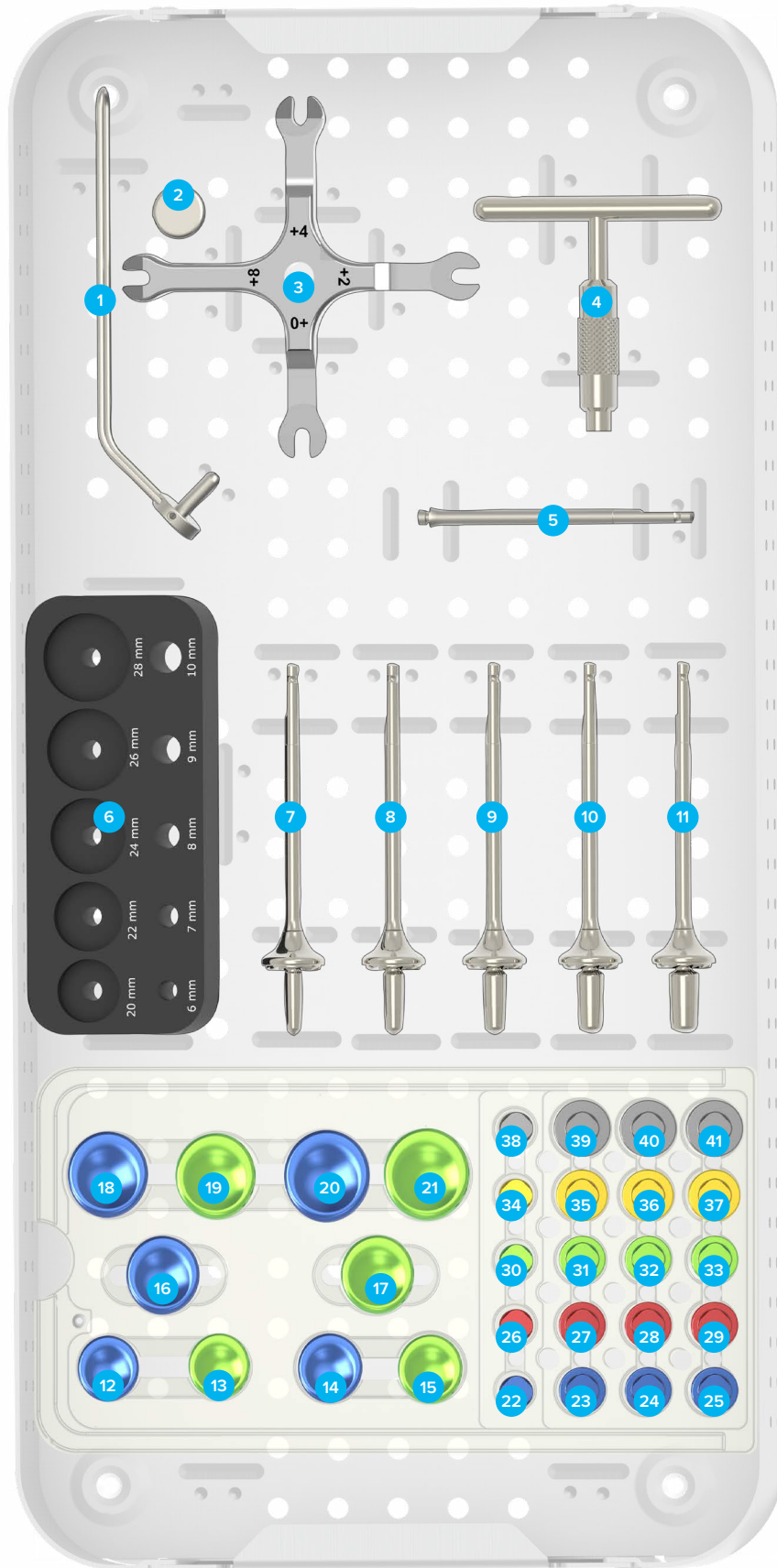

Ordering Information [continued]

Tray Components

Instrumentation

1	6 mm Broach Assembly	TR-BRA06	6	7 mm Broach Assembly	TR-BRA07
2	5.5 mm Quick Release Awl	TR-0206	7	8 mm Broach Assembly	TR-BRA08
3	10 mm Broach Assembly	TR-BRA10	8	9 mm Broach Assembly	TR-BRA09
4	AT2 Screw Sizer	AT2-SMCZ	9	Large Cannulated Quick Release Driver Handle	MS-3200
5	Head Impactor	TR-MS05			



Ordering Information [continued]

Tray Components

Instrumentation

1	.045" x 6" ST Guide Wire	WS-1106ST	6	Micro Acutrak 2 Drill	AT2-1509
2	2.0 mm Cannulated Quick Release Driver Tip	HT-1120	7	Micro Acutrak 2 Drill, Long	80-0100
3	Mini Acutrak 2® Drill	AT2M-1813	8	1.5 mm Cannulated Quick Release Driver Tip	HT-0915
4	Mini Acutrak 2 Drill, Long	AT2M-L1813	9	.035" x 5.75" ST Guide Wire	WS-0906ST
5	.045 Diameter, Parallel Wire Guide Assembly	AT2-4500	10	.035 Diameter, Parallel Wire Guide Assembly	AT2-3500

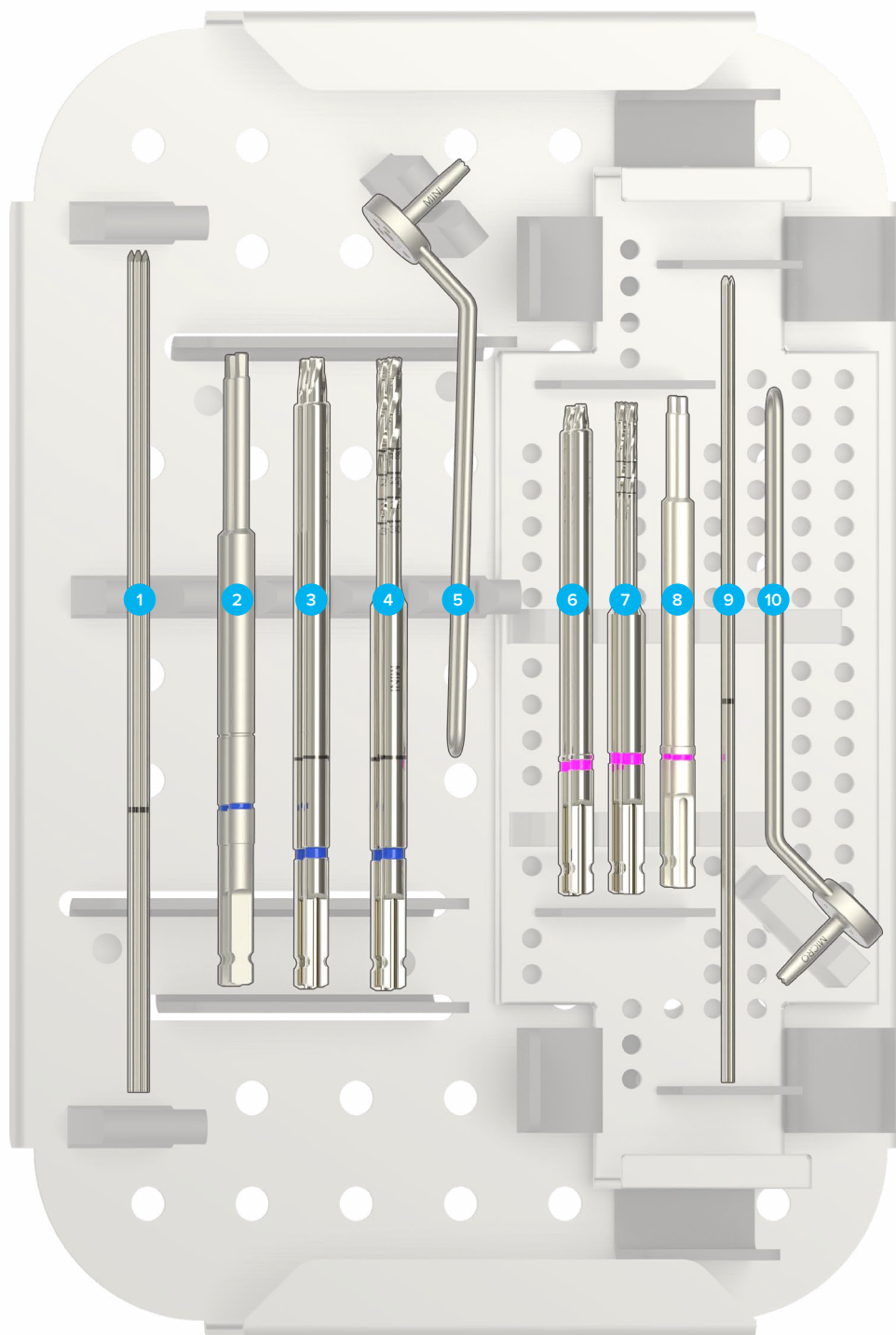

Ordering Information [continued]

Sterile Components			
Head Implants		Stem Implants	
20.0 mm Head, Right	TR-H200R-S	6.0 mm x 0.0 mm Stem	TR-S0600-S
20.0 mm Head, Left	TR-H200L-S	6.0 mm x 2.0 mm Stem	TR-S0602-S
22.0 mm Head, Right	TR-H220R-S	6.0 mm x 4.0 mm Stem	TR-S0604-S
22.0 mm Head, Left	TR-H220L-S	6.0 mm x 8.0 mm Stem	TR-S0608-S
24.0 mm Head, Right	TR-H240R-S	7.0 mm x 0.0 mm Stem	TR-S0700-S
24.0 mm Head, Left	TR-H240L-S	7.0 mm x 2.0 mm Stem	TR-S0702-S
26.0 mm Head, Right	TR-H260R-S	7.0 mm x 4.0 mm Stem	TR-S0704-S
26.0 mm Head, Left	TR-H260L-S	7.0 mm x 8.0 mm Stem	TR-S0708-S
28.0 mm Head, Right	TR-H280R-S	8.0 mm x 0.0 mm Stem	TR-S0800-S
28.0 mm Head, Left	TR-H280L-S	8.0 mm x 2.0 mm Stem	TR-S0802-S
		8.0 mm x 4.0 mm Stem	TR-S0804-S
		8.0 mm x 8.0 mm Stem	TR-S0808-S
		9.0 mm x 0.0 mm Stem	TR-S0900-S
		9.0 mm x 2.0 mm Stem	TR-S0902-S
		9.0 mm x 4.0 mm Stem	TR-S0904-S
		9.0 mm x 8.0 mm Stem	TR-S0908-S
		10.0 mm x 0.0 mm Stem	TR-S1000-S
		10.0 mm x 2.0 mm Stem	TR-S1002-S
		10.0 mm x 4.0 mm Stem	TR-S1004-S
		10.0 mm x 8.0 mm Stem	TR-S1008-S
Instruments			
Stem Removal Tool	TR-MS30		
Total Radial Head Tray Lid	TR-0002		
Total Radial Head Tray Base	TR-0003		
Total Radial Head Top Tray	TR-0004		
Total Radial Head Bottom Tray	TR-0005		
Total Radial Head Trial Caddy	TR-0006		
Optional Items			
6.0 mm x 6.0 mm Stem	TR-S0606-S	8.0 mm x 6.0 mm Trial Stem	TR-TS86
7.0 mm x 6.0 mm Stem	TR-S0706-S	9.0 mm x 6.0 mm Trial Stem	TR-TS96
8.0 mm x 6.0 mm Stem	TR-S0806-S	10.0 mm x 6.0 mm Trial Stem	TR-TS106
9.0 mm x 6.0 mm Stem	TR-S0906-S	ARH STD & Optional Trial Gauge	80-0832
10.0 mm x 6.0 mm Stem	TR-S1006-S	ARH STD & Optional Trial Caddy Base	80-0833
6.0 mm x 6.0 mm Trial Stem	TR-TS66	ARH STD & Optional Trial Caddy Lid	80-0857
7.0 mm x 6.0 mm Trial Stem	TR-TS76		

References

1. Van Riet RP, Van Glabbeek F, Neale PG, Bimmel R, Bortier H, Morrey BF, O'Driscoll SW, An KN. Anatomical considerations of the radius. *Clin Anat*. 2004 Oct;17(7):564-9.
2. Swieszkowski W, Skalski K, Pomianowski S, Kedzior K. The anatomic features of the radial head and their implication for prosthesis design. *Clin Biomech* (Bristol, Avon). 2001 Dec;16(10):880-7.
3. King GJ, Zarzour ZD, Patterson SD, Johnson JA. An anthropometric study of the radial head: implications in the design of a prosthesis. *J Arthroplasty*. 2001 Jan;16(1):112-6.
4. Bachman DR, Thaveepunsan S, Park S, Fitzsimmons JS, An KN, O'Driscoll SW. The effect of prosthetic radial head geometry on the distribution and magnitude of radiocapitellar joint contact pressures. *J Hand Surg Am*. 2015 Feb;40(2):281-8.



www.acumed.net

Acumed USA Campus
5885 NE Cornelius Pass Road
Hillsboro, OR 97124
+1.888.627.9957

OsteoMed USA Campus
3885 Arapaho Road
Addison, TX 75001
+1.800.456.7779

Acumed Iberica Campus
C. de Álvaro Caballero, 14,
28023 Madrid, Spain
+34.913.51.63.57

ELB00-04-D | Effective: 2023/02 | © 2023 Acumed® LLC

These materials contain information about products that may or may not be available in any particular country or may be available under different trademarks in different countries. The products may be approved or cleared by governmental regulatory organizations for sale or use with different indications or restrictions in different countries. Products may not be approved for use in all countries. Nothing contained in these materials should be construed as a promotion or solicitation for any product or for the use of any product in a particular way that is not authorized under the laws and regulations of the country where the reader is located. Nothing in these materials should be construed as a representation or warranty as to the efficacy or quality of any product, nor the appropriateness of any product to treat any specific condition. Physicians may direct questions about the availability and use of the products described in these materials to their authorized Acumed distributor. Specific questions patients may have about the use of the products described in these materials or the appropriateness for their own conditions should be directed to their own physician.

Refer to the provided instructions for use for the complete indications, contraindications, warnings, and instructions for use.

OsteoMed LLC is a wholly owned subsidiary of Acumed LLC.
OsteoMed® is a registered trademark of OsteoMed LLC.
Acumed® is a registered trademark of Acumed LLC.