



Zimmer® Natural Nail® System

Antegrade Femoral Nail
Surgical Technique

(Piriformis Fossa & Greater Trochanteric Approaches)



**Zimmer
Natural Nail System
Antegrade Femoral Nail
Surgical Technique**

Table of Contents	
Product Overview	2
Implant Overview	2
Indications	3
Contraindications	3
Surgical Technique	3
Preoperative Planning	3
Patient Positioning	3
Reduction	3
Greater Trochanter Entry Point	4
Piriformis Fossa Entry Point	5
Proximal Reaming	7
Shaft Reaming	8
Nail Assembly and Insertion	8
Greater Trochanter Entry Point Nail Insertion	9
Piriformis Fossa Entry Point Nail Insertion	9
Proximal Screw Placement	11
Distal Targeting – Freehand Technique	15
Finalize Implant Placement	16
Postoperative Care	16
Nail Extraction	16
Antegrade Femur PF Nail Details	17
Antegrade Femur GT Nail Details	18
Case Examples	20
Product Information	21

Product Overview

The *Zimmer® Natural Nail® System* is a system of intramedullary (IM) nails, screws, instruments and other associated implants that are designed to provide stable internal fixation for fractured long bones. The nails have been designed for specific applications to help restore the shape of the fractured bone to its natural, pre-injured state.

The Antegrade Femur nails are designed to help treat various fractures of the femur. Different nails are available to be placed through the tip of the Greater Trochanter or through the Piriformis Fossa. Screws are placed through the nail to secure the implant in place and maintain length and alignment while healing occurs. The nails have multiple screw holes in the proximal body to allow surgeons to address different fracture types. Proximal and distal slots allow for compression or dynamization across a fracture.

Implant Overview

Greater Trochanter

Nail Diameters: 8.3, 9.3, 10, 11, 12, 13, 14mm

Nail Lengths: 8.3mm, 24 to 40cm in 2cm increments

9.3mm and larger, 24 to 48cm in 2cm increments

CCD Angle: 132°

Piriformis Fossa

Nail Diameters: 9.3, 10, 11, 12, 13, 14, 15mm

Nail Lengths: 24 to 48cm in 2cm increments

CCD Angle: 128° Universal

Proximal Screw Diameters

5.0mm for transverse holes (with Stabilize Technology)

6.0mm for Recon/Descending holes

Distal Screw Diameters (with Stabilize Technology)

4.0mm for 8.3mm nails

5.0mm for 9.3mm and larger nails

Screw Lengths

4.0mm: 20 to 60mm in 2.5mm increments

65 to 100mm in 5mm increments

5.0mm: 20 to 60mm in 2.5mm increments

65 to 100mm in 5mm increments

6.0mm: 50 to 140mm in 5mm increments

Screws available in fully- and partially-threaded configurations.

Materials: Ti-6Al-4V alloy

Precision instrumentation is provided to help implant the nail. Many of the instruments and implants feature a color coding system to help the surgical team use the system. Certain universal instruments are not color coded. The color coding system is referenced in the technique. A wall chart (97-2491-003-00) is also available to help explain the color coding system.

Indications

The *Zimmer Natural Nail* system is indicated for temporary fracture fixation and stabilization of the bone.

Indications for use of the Greater Trochanter and Piriformis Fossa nails in the femur include:

- Compound and simple shaft fractures
- Proximal, metaphyseal and distal shaft fractures
- Segmental fractures
- Comminuted fractures
- Fractures involving osteopenic and osteoporotic bone
- Pathological fractures
- Fractures with bone loss
- Pseudoarthrosis, non-union, mal-union and delayed union
- Periprosthetic fractures
- Surgically created defects such as osteotomies
- Intertrochanteric and subtrochanteric fractures

Contraindications

- A medullary canal obliterated by a previous fracture or tumor
- Bone shaft having excessive bow or deformity
- Lack of bone substance or bone quality which makes stable seating of the implant impossible
- All concomitant diseases that can impair the functioning and the success of the implant
- Infection
- Insufficient blood circulation
- Skeletally immature patients

WARNING: This nail should only be used to treat a periprosthetic fracture if the in situ device is firmly fixed. When treating a periprosthetic fracture, the nail should be positioned so that it does not come in contact with the in situ device.

Surgical Technique

Preoperative Planning

Preoperative planning is recommended before beginning the surgical procedure. A/P and Lateral x-rays of the injured femur should be taken preoperatively and evaluated for length, canal size and implant suitability. A/P and Lateral x-rays of the contralateral uninjured femur can also be taken preoperatively to provide insight into the characteristics of the pre-injured femur.

Patient Positioning

The patient should be positioned in either a lateral or supine position. If positioned in a supine position, a bump should be placed under the hip of the injured femur to elevate it slightly. The use of a fracture table can be beneficial to help during fracture reduction as well as to facilitate intraoperative imaging with a C-arm. The C-arm should be placed to allow for imaging of the femur in both planes along the entire length of the bone. If reconstruction screws are planned, the C-arm must allow for lateral imaging of the femoral head and neck. Adduction of the injured femur can also be helpful when placing reconstruction screws.

Drape the patient appropriately to allow the surgeon to work from the hip to the knee.

Reduction

It is critical to achieve anatomic reduction before beginning any of the steps to place the IM Nail. Traction should be used as necessary to help achieve fracture reduction. Several instruments are available to assist in fracture reduction including clamps, reduction tongs, ball spike pushers and Steinman pins.

Certain portions of the surgical procedure differ depending on whether a surgeon chooses to use a Greater Trochanter Entry Point Nail or a Piriformis Fossa Entry Point Nail. Please follow the appropriate portion of the technique that directs use of the chosen nail type. Most pictures depict use of the Greater Trochanteric Entry Point. Do not attempt to use the Greater Trochanter Entry Point Nail through a Piriformis Fossa Entry Point or vice versa.

Greater Trochanter Entry Point

Starting Point Location

The starting point for the nail is located on the tip of the greater trochanter (Figure 1). On the AP image, the starting point should be on the tip of the greater trochanter, not lateral. On the lateral image, the starting point should be in the midpoint of the greater trochanter. For a proximal femur fracture where recon screws will be used, the entry point on the lateral image is at the junction of the anterior 1/3 and the posterior 2/3 of the greater trochanter.

Begin the skin incision 3cm proximal to the greater trochanter. A larger incision may be desired for obese patients. Split the fascia of the gluteus maximus in line with its fibers. Identify the subfascial plane of the gluteus medius, and palpate the posterior tip of the greater trochanter. A 3.0mm threaded pin can also be used to create a stab incision and advanced down to the greater trochanter (Figure 2). The ENTRY CANNULA STARTING POINT LOCATOR placed inside the ENTRY CANNULA can also assist with dissection down to the bone (Figure 3).



Fig. 1



Fig. 2

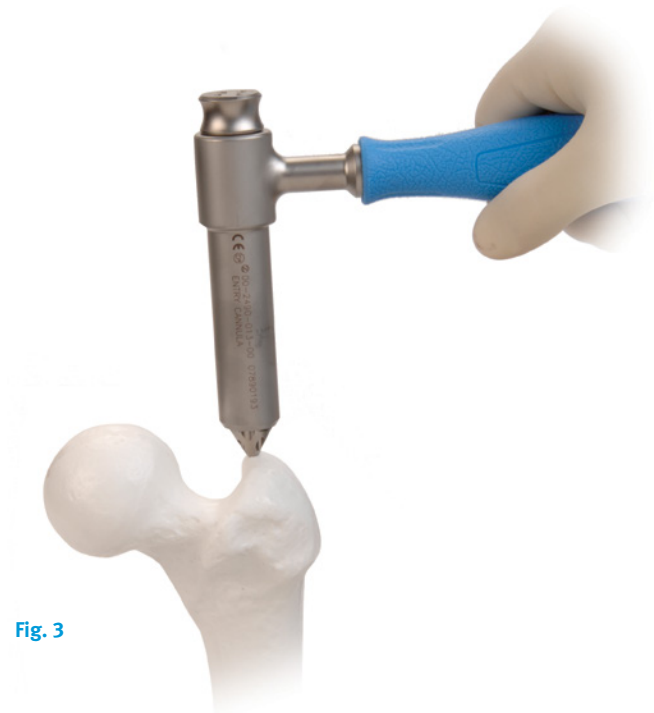

Fig. 3

Piriformis Fossa Entry Point

Starting Point Location

The starting point for the nail is located in the piriformis fossa for a standard shaft fracture (Figure 1). For a proximal femur fracture where recon screws will be used, the entry point is 5mm anterior to the normal piriformis entry point. Begin the skin incision 3cm proximal to the greater trochanter. A larger incision may be desired for obese patients. Split the fascia of the gluteus maximus in line with its fibers. Identify the subfascial plane of the gluteus medius, and palpate the posterior tip of the greater trochanter. A 3.0mm threaded pin can also be used to create a stab incision and gain entry into the fossa (figure 2). The ENTRY CANNULA STARTING POINT LOCATOR placed inside the ENTRY CANNULA can also assist with dissection down to the bone (Figure3).



Fig. 1



Fig. 2

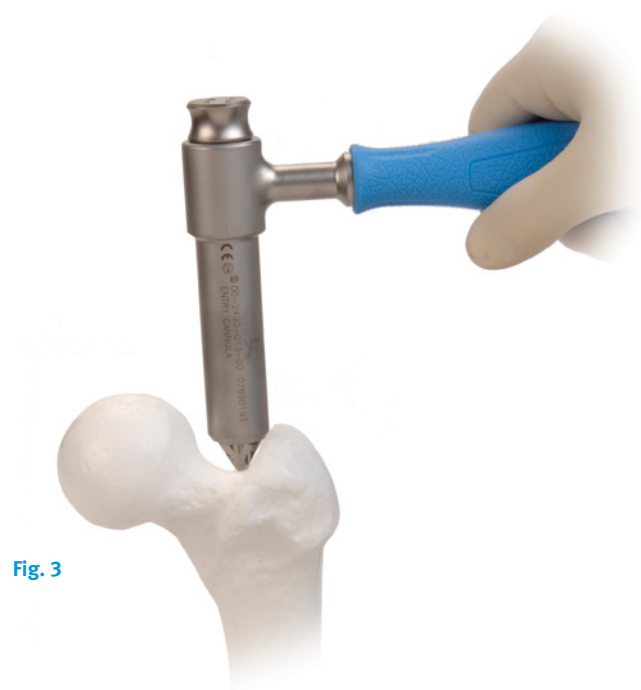

Fig. 3

Place the 3.0mm threaded pin into the starting point. Use the C-arm to visualize the pin's position from A/P and Lateral views. The pin should be inserted at the identified point in the direction of the center of the medullary canal.

Drive the pin through the starting point into the center of the medullary canal. Use the 8.0mm ENTRY REAMER to ream an entry portal into the proximal femur through the starting point (Figure 4). Remove the reamer and 3.0mm pin.



Fig. 4

Alternatively, an AWL can be used to use the entry point and create the entry point.

Place a 3.0mm x 100cm BALL TIP WIRE (00/47-2255-008-01) into the medullary canal all the way into the femur (Figure 5). To aid in manipulation, bend the tip of the guide wire at 10 degrees angle 5cm from the entry point.

CAUTION: If the guide wire is bent shorter than 5cm from the end of the wire and/or more than 10 degrees it may be difficult to remove from the nail. If the wire becomes lodged inside the nail, utilize the GUIDE WIRE GRIPPER and mallet to remove the guide wire from the nail.

Fluoroscopy can assist you in guiding the wire past the fracture site. If you plan to ream the canal of the femur, the ball tip wire should be centered and embedded in the distal femur at the level of the

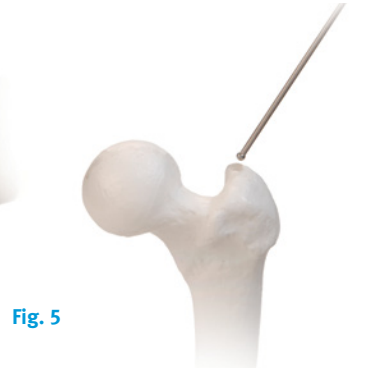

Fig. 5



Fig. 6

distal epiphyseal scar using the GUIDE WIRE GRIPPER and a MALLET (Figure 6). Care should be taken not to drive the wire through the distal femur.



Fig. 7

A REDUCTION FINGER is included in the set. The ball tip guide wire can be fed retrograde through the REDUCTION FINGER. The REDUCTION FINGER can then be placed into the femur and used to help reduce the femur from the inside as well as to help facilitate passage of the guide wire past the fracture site.

Assemble the two piece NAIL LENGTH GAUGE. Slide the tube portion of the gauge over the 3.0mm x 100cm ball tip guide wire until the tip of the tube is at the level of the entry point (confirm position using fluoroscopy) (Figure 7). The proximal end of the ball tip guide wire indicates the length of the wire in the canal. When determining nail length, consideration should be taken as to how deep the nail will be inserted into the femur based upon the desired location of the proximal screws. A RULER is also included in the set which can be used to radiographically determine nail length.

Proximal Reaming

Use the 14.5mm TAPERED REAMER to prepare the proximal femur for the proximal portion of the nail (Figure 8). The C-arm should be used to visualize the depth of the reamer in the proximal femur. Care should be taken to keep the reamer in line with the shaft of the femur to avoid reaming through the cortex of the femur.



Fig. 8

The 14.5mm TAPERED REAMER has three grooves on it. The most proximal groove indicates the final position of the top of the nail. The two distal grooves help visualize the placement of the recon screws. Visualizing a line between these grooves on each side of the reamer (under fluoroscopy) will indicate the approximate centerline between the recon screws to help facilitate placement in the femoral neck and head.

8.3mm Greater Trochanter Entry Point

Nail Note: The 8.3mm nail has a proximal diameter of 12.0mm. With this size nail, a shaft reamer should be used, instead of the 14.5mm TAPERED or CHANNEL REAMER, to create an opening 13.0 to 13.5mm in diameter proximally. This will allow the head of the nail to be safely inserted into the bone, without removing an excess amount of bone.

A CHANNEL REAMER is also available for proximal reaming. The INNER CHANNEL REAMER is placed inside the 14.5mm CHANNEL REAMER SLEEVE and secured by twisting the connector. The CHANNEL REAMER is then advanced over the guide wire through the piriformis fossa/greater trochanter. Advance the reamer to level of the lesser trochanter (Figure 9) or deep enough to accommodate the proximal body of the nail. Care should be taken to keep the reamer in line with the shaft of the femur to avoid reaming through the cortex of the femur.

After reaming to the proper depth to accommodate the proximal body of the nail, the INNER CHANNEL REAMER is removed by disengaging the connector and pulling the INNER CHANNEL REAMER out of the surgical field (Figure 10). The CHANNEL REAMER SLEEVE can be left in place to act as a tissue protection sleeve during shaft reaming for shaft reamers up to 13mm in diameter. To achieve greater reaming depth or diameter, the ENTRY CANNULA can be used in place of the sleeve. To facilitate reamer removal



Fig. 9

via the sleeve, power the reamer until it enters the sleeve. Following shaft reaming the CHANNEL REAMER SLEEVE should be removed from the surgical field (Figure 11).



Fig. 10

Fig. 11

Shaft Reaming

Start with a small Zimmer® Pressure Sentinel® Reamer. Increase the diameter of the reamer by 0.5 - 1.0mm depending on the amount of resistance felt while reaming (Figure 13). The GUIDE WIRE PUSHER can help prevent the ball tip guide wire from coming out of the femur during reaming. When cortical chatter occurs, stop reaming. Choose a nail that is 1.0 – 1.5mm smaller than the last reamer used. The proximal diameter of nails smaller than 13mm is 13mm. For nails 13mm and larger in diameter, the diameter of the nail is constant.

NOTE: If the Guide Wire becomes lodged within the reamer, use the Guide Wire



Fig. 13



Fig. 14

Pusher to push the Guide Wire back into the IM canal.

Nail Assembly and Insertion

The color code for the antegrade femur nails is GREEN. Ti-6Al-4V alloy nails, the TARGETING GUIDE and the CONNECTING BOLT all have GREEN colors on them, as well as the word GREEN etched on them.

Place the CONNECTING BOLT through the barrel of the TARGETING GUIDE HANDLE (Figure 14). Rotate the nail around the CONNECTING BOLT to begin threading the bolt into the proximal portion of the nail. Completely tighten the CONNECTING BOLT to secure the nail to the guide. The arrow on the barrel of the TARGETING GUIDE HANDLE will line up with the arrow and appropriate letter on nail (R for Right Femur, L for Left Femur) when the nail is correctly aligned. Ensure that the nail is tightened to the barrel of the guide and that the teeth on the barrel interdigitate with the notches in the nail (Figure 15).

Use a screw cannula, drill sleeve and drill bit to verify that the holes in the guide target the holes in the nail. If using descending interlocking or reconstruction screws, the appropriate TARGETING MODULE should be attached to verify that the drills line up with the holes in the nail. Thread the connecting knob into the module before attaching the module to the guide.



Fig. 15

Note: Remove the TARGETING MODULE before inserting the nail.

Greater Trochanter Entry Point Nail Insertion

Insert the nail over the guide wire with the arm of the guide facing anterior to the patient (Figure 16GT). The guide will turn 90° as it passes down the femoral canal. The combination of the nail's anatomic shape as well as the flutes in the nail will

help the nail rotate as it passes down the canal. Monitor the progression of the nail using the C-arm, especially as the nail is passing through or near the fracture site.

Piriformis Fossa Entry Point Nail Insertion



Fig. 16GT



Fig. 16PF

CAUTION: Do not pry excessively on the targeting guide as damage may result.

Insert the nail over the guide wire with the arm of the guide facing lateral to the patient (Figure 16PF). Monitor the progression of the nail down the canal using the C-arm, especially as the nail is passing through or near the fracture site.

If the nail does not pass down the canal easily, attach the IMPACTION HEAD to the TARGETING GUIDE HANDLE. Using the MALLET, impact gently on the IMPACTION HEAD (Figure 17). Do not strike the guide.

CAUTION: Do not strike excessively as damage to the targeting guide and bone

may result.

Verify that the CONNECTING BOLT is tight while impacting. Do not impact on any other portion of the TARGETING GUIDE HANDLE or MODULE as this may break the guide or cause it to lose its accuracy.

If the nail will not advance with impaction, remove the nail at canal to a larger diameter at 0.5 mm increments or consider smaller diameter nail. Place the nail in line with or below of the entry point, depending position relative to the expected location.



Fig. 17



Fig. 18

Remove the ball tip guide wire from the nail using the GUIDE WIRE GRIPPER (Figure 18). If possible, the guide wire should be removed before the nail is completely seated to reduce the potential for the wire to get caught in the nail. If the wire is difficult to remove, rotate the wire 90° with the GUIDE WIRE GRIPPER while pulling the wire.

Proximal Screw Placement

Proximal Screw Diameter:

6.0mm for Reconstruction or Descending Interlocking Screws, 5.0mm for Transverse Interlocking Screws

Proximal Screw Lengths:

6.0mm – 50 to 140mm in 5mm increments

5.0mm - 20 to 60mm in 2.5mm increments, 65 to 100mm in 5mm increments

Distal Screw Diameter:

5.0mm for 9.3 to 15mm nails, 4.0mm for 8.3mm nails (Greater Troch Nail Only)

Distal Screw Lengths:

20 to 60mm in 2.5mm increments, 65 to 100mm in 5mm increments

The reconstruction screw holes in the nail should be used with partially threaded 6.0mm screws. The descending interlock holes should be used with fixed angle 6.0mm screws although this will not create a fixed angle construct. The transverse interlocking holes use 5.0mm screws. A fixed angle construct can be created by using 5.0mm fixed angle screws in these holes. If a fixed angle construct is not desired*, partially threaded 5.0mm screws should be used in the transverse interlocking holes.

The instruments needed to place screws through the proximal portion of the nail are color coded according to the chart.

INSTRUMENT TYPE	SMALL
Large Diameter Screw Cannula (recon/interlock screws)	Orange
Small Diameter Screw Cannula (transverse screws)	Orange
Trocar	Orange
4.3mm Drill Sleeve (5.0mm screws)	Orange / Red
4.3mm Drill Bit (5.0mm screws)	Orange / Red
4.9mm Drill Sleeve (6.0mm screws)	Orange / Black
4.9mm Drill Bit (6.0mm screws)	Orange / Black
3.0mm Pin Sleeve	Orange
Depth Gauge	Orange
Screwdriver	Orange

Note: 4.0 screws contain the color/color name WHITE on the label and corresponding screw case. 5.0mm screws contain the color/color name of RED on the label and corresponding screw case. 6.0mm screws contain the color/color name of BLACK on the label and screw case. These colors match the color rings on the drills and other relevant instruments.

CAUTION: Retighten the CONNECTING BOLT to the nail to maintain targeting accuracy. If modules inadvertently left on during impaction, retighten CONNECTINGS KNOBS to maintain targeting accuracy.

If using the descending interlocking or reconstruction screws, attach the appropriate TARGETING MODULE to the TARGETING GUIDE HANDLE. Select the screw holes that will be used in the nail. Insert HOLE INDICATORS in the holes in the TARGETING GUIDE HANDLE and TARGETING MODULE that WILL NOT be used.



Recon Module



Interlocking Module

Note: The proximal pattern on the 8.3mm nail differs from the larger diameter nails. See page 19 for details.

The following proximal screw combinations are NOT possible because the screws may run into one another.



Distal Recon Screw and Distal Descending Oblique - 6.0mm Screws

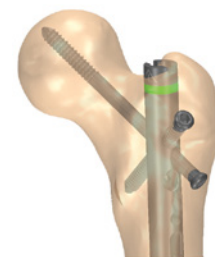

Proximal Recon Screw and Proximal Descending Oblique - 6.0mm Screws



Distal Descending Oblique 6.0mm and 5.0mm Static Transverse Screw



Distal 6.0mm Recon Screw and 5.0mm Static Transverse Screw



Static Transverse and Proximal Dynamization - 5.0mm Screws

* Under certain conditions, especially in patients with thin cortical bone, Partially Threaded Screws from 20mm to 32.5mm in length may form a Fixed Angle construct with the nail.

Fig. 19



Slide the TROCAR into the SCREW CANNULA (Figure 19). Slide the SCREW CANNULA through one of the selected holes in the TARGETING GUIDE or MODULE. Incise the skin at the point the TROCAR touches it and dissect through the tissue down to the bone to make a path for the SCREW CANNULA. Advance the SCREW CANNULA until the tip of the TROCAR is against the bone (Figure 20).

CAUTION: Do not impact on the cannula.

Remove the TROCAR. Insert the appropriate sized DRILL SLEEVE through the CANNULA down to the bone. Place the appropriate sized DRILL BIT through the DRILL SLEEVE (Figure 21). Before the DRILL BIT contacts the bone, start the drill. Advance the spinning DRILL BIT through the bone bicortically. Use fluoroscopy to verify the appropriate location of the DRILL BIT in the bone. (Note: if reconstruction screws are used, do not advance the DRILL BIT through the second cortex of the bone. Only advance it as far as is necessary to obtain proper fixation.)

CAUTION: In cases where hard cortical bone is encountered or at the surgeon's preference, a 5.0mm TAP can be used to ease insertion of the screws.

Fig. 20



Fig. 21



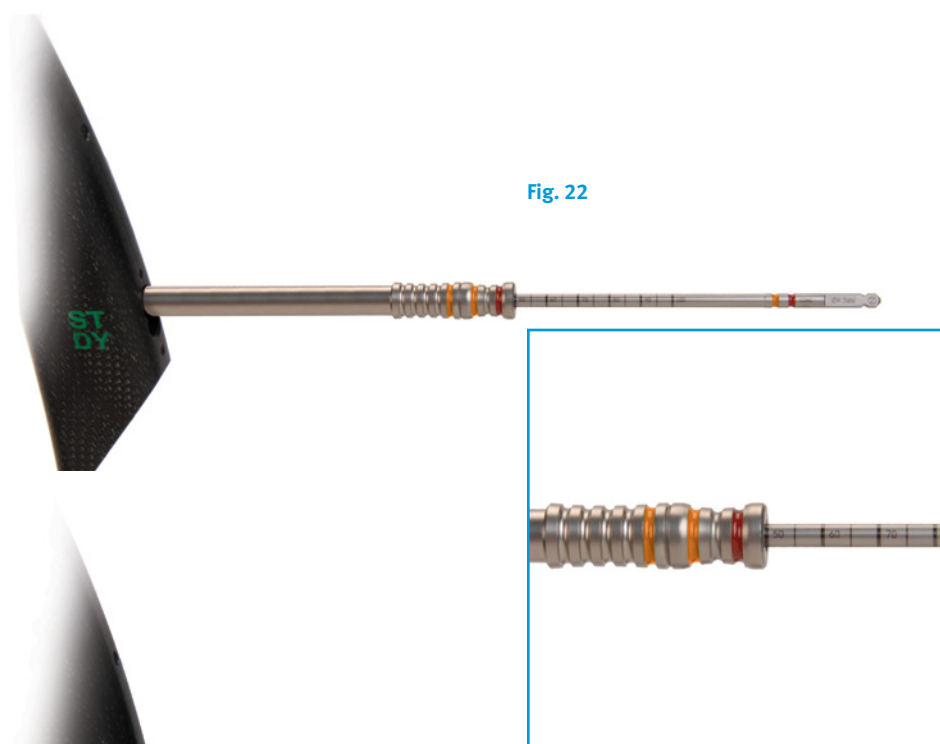

Fig. 22

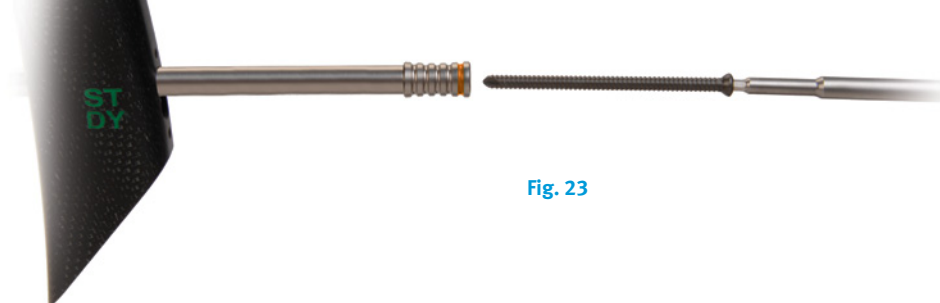

Fig. 23

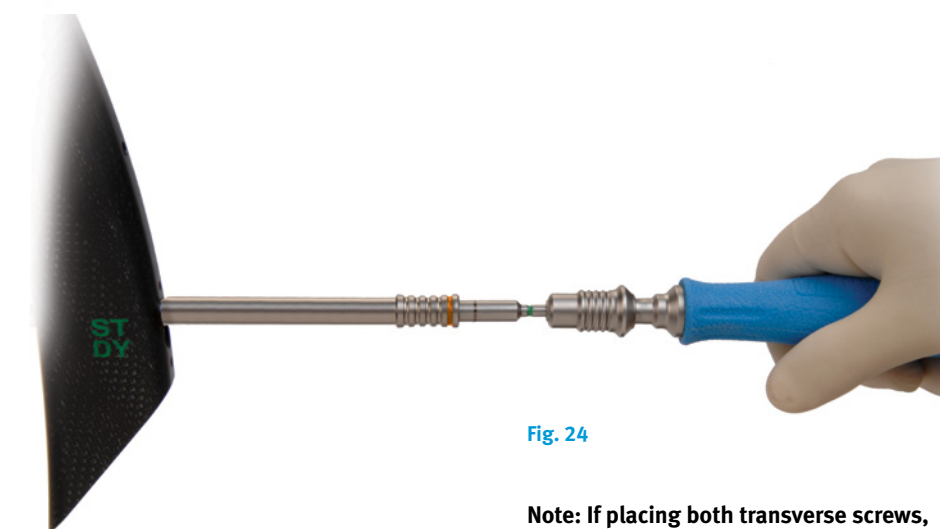

Fig. 24

Note: If placing both transverse screws, place the static screw first. When placing the dynamic screw, advance the cannula to the top of the static screw head. Do not advance the cannula to the bone.

With the DRILL BIT in place and the DRILL SLEEVE pressed against the bone, the length of screw needed is indicated by the etch marks on the DRILL BIT where it exits the DRILL SLEEVE (Figure 22). The tip of the drill should be no more than 5mm through the far cortex of the bone to reduce the risk of complications associated with screw protrusion. (Alternatively, the DRILL BIT and DRILL SLEEVE can be removed and the SCREW DEPTH GAUGE used to measure the length of screw.)

Remove the DRILL BIT and DRILL SLEEVE. Place the appropriate length and diameter screw through the SCREW CANNULA into the bone (Figure 23). Use the 3.5mm HEX SCREWDRIVER to advance the screw to achieve bicortical purchase (Figure 24) (the screw head should sit on the near cortex of the bone) (Figure 25). The screws are self tapping so tapping should not be necessary.

If using the CAPTURED SCREWDRIVER, place the appropriate screw on the 3.5mm HEX and tighten the screw to the CAPTURED SCREWDRIVER by turning the knob next to the handle clockwise.

CAUTION: When using any screwdriver, do not torque it beyond the calibration line next to the handle. Do not drive the screws into the bone under power, as damage to the bone, screws or nail could result.

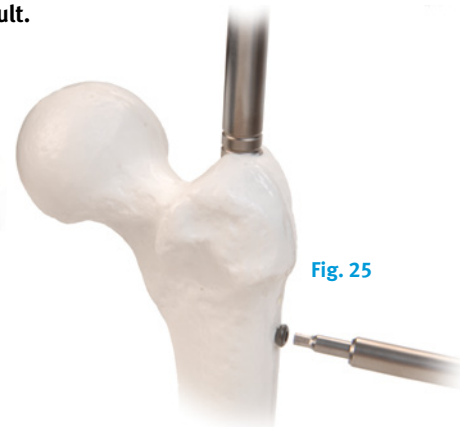

Fig. 25

Repeat this technique to place additional proximal screws as necessary.

Distal Targeting – Freehand Technique

All nails 9.3mm in diameter and larger use a 5.0mm screw (4.3mm drill bit) distally. The 8.3mm Greater Trochanter Entry Point Nail uses a 4.0mm screw (3.3mm drill bit) distally. Use the 3.3mm (color coded WHITE) drill bit and 4.0mm (color coded WHITE) screws when using the 8.3mm Greater Troch Nail in place of the 4.3mm bit and 5.0mm screws listed below.

Insert the 4.3mm FREE HAND DRILL BIT (color coded RED) into the FREE HAND TARGETING WAND. Finger tighten the SET SCREW. Position the C-arm in order to get a lateral view of the distal femur. Adjust the position of the C-arm so that the hole through the nail appears as a perfect circle on the monitor. Bring the tip of the drill bit to the skin and use the C-arm to center it over the hole that you desire to place a screw through. Make a stab incision at this point and dissect down to the bone. Place the tip of the drill bit against the bone (Figure 26). Verify that the tip of the drill bit is in the center of the hole. Align the drill bit with the C-arm by turning the handle of the drill bit against the bone using

Loosen the SET SCREW and remove the FREE HAND TARGETING WAND, leaving the DRILL BIT in place. Slide the FREE HAND TISSUE PROTECTION SLEEVE over the DRILL BIT (Figure 27). Attach the DRILL to the DRILL BIT and advance the drill bit through the bone. Verify that the drill bit has gone through the hole in the nail.

Fig. 26



Fig. 27



Remove the drill bit. Measure the depth of the hole using the FREE HAND SCREW DEPTH GAUGE (Figure 28). (Alternatively, the appropriate length of screw can be measured using the numbered etch on the DRILL BIT closest to the end of the FREE HAND TISSUE PROTECTION SLEEVE when the DRILL BIT is in the bone and the SLEEVE is touching the bone.) Insert the appropriate length screw using the 3.5mm HEX SCREWDRIVER (Figure 29).

If using the CAPTURED SCREWDRIVER, place the appropriate screw on the 3.5mm HEX and tighten the screw to the CAPTURED SCREWDRIVER by turning the knob next to the handle clockwise.

CAUTION: If using the CAPTURED SCREWDRIVER, do not torque the CAPTURED SCREWDRIVER beyond the calibration line next to the handle. Do not drive the screws into the bone under power, as damage to the bone, screws and nail could result.

Repeat these steps to insert additional distal screws.

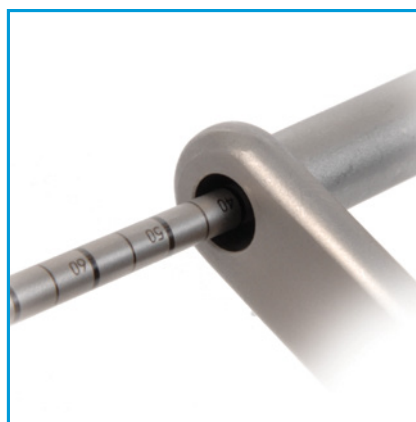

Fig. 28



Fig. 29



Finalize Implant Placement

Observe the depth of the nail in the proximal femur. Ridges in the targeting guide barrel indicate 5 and 10mm of depth. A 3.0mm pin can be placed through the hole in the guide to approximate the position of the top of the nail.

Disconnect any TARGETING MODULES from the TARGETING GUIDE HANDLE and set aside. Place a 2.0MM GUIDE PIN through the CONNECTING BOLT down to the level of the proximal screws. Loosen and remove the CONNECTING BOLT from the nail. Remove the TARGETING GUIDE HANDLE and set aside.

Choose the appropriate height cannulated NAIL CAP. Secure the selected NAIL CAP to the NAIL CAP INSERTER using the NAIL CAP RETAINING SHAFT. Slide the cannulated NAIL CAP over the 2.0MM GUIDE PIN and tighten to the nail. Using the C-arm, verify that the cap is completely seated to the top of the nail.

Disengage the NAIL CAP INSERTER from the NAIL CAP. Remove the 2.0MM GUIDE PIN.

Close all wounds and apply the appropriate dressings.

If a module was used, remove the connecting knob from the module before cleaning and sterilization.

Postoperative Care

Early range of motion exercises of the hip and knee are encouraged. Allow toe-touch weight bearing to progress to full weight bearing as fracture callus increases on the x-ray films.*

Nail Extraction

Use the C-arm to locate any distal screws. Remove the distal screws using a 3.5mm HEX SCREWDRIVER. Remove the nail cap (if one was inserted) with a 5.0mm HEX SCREWDRIVER. Expose the proximal screws and use a 3.5mm HEX SCREWDRIVER to remove them. If bone has grown into any of the screws, nail cap or nail that would inhibit implant removal, use instruments such as rongeurs, dental picks or drills to remove bone in-growth before attempting implant removal. Take care not to damage the implant itself while removing ingrown bone.

To remove the nail, slide a 2.0MM GUIDE PIN into the top of the nail. Insert the CANNULATED EXTRACTION ADAPTER over the wire into the top of the nail (Figure 30). Tighten the adapter to the nail using a PIN WRENCH. Attach a saphammer or other impaction device and impact to back out the nail (Figure 31).

Greater Trochanter Entry Point Nail Note:

The nail will rotate approximately 90° as it is removed from the femur.

Fig. 30

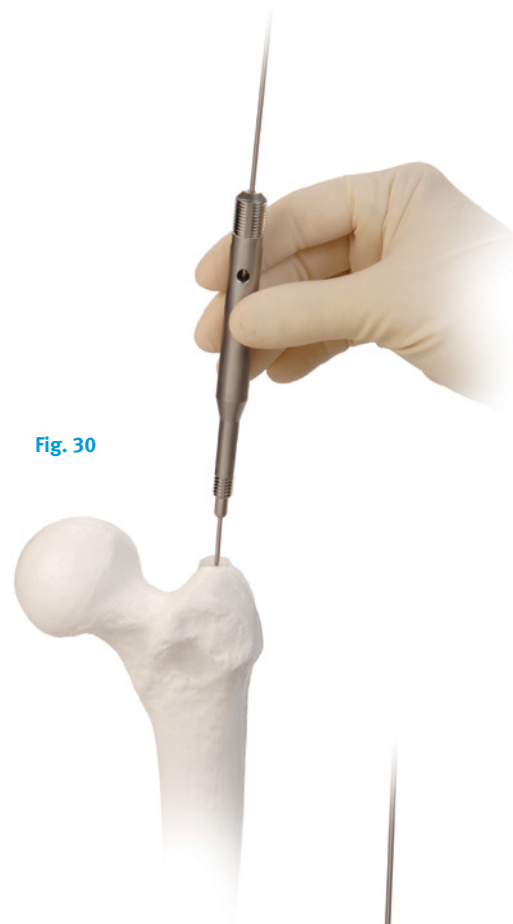
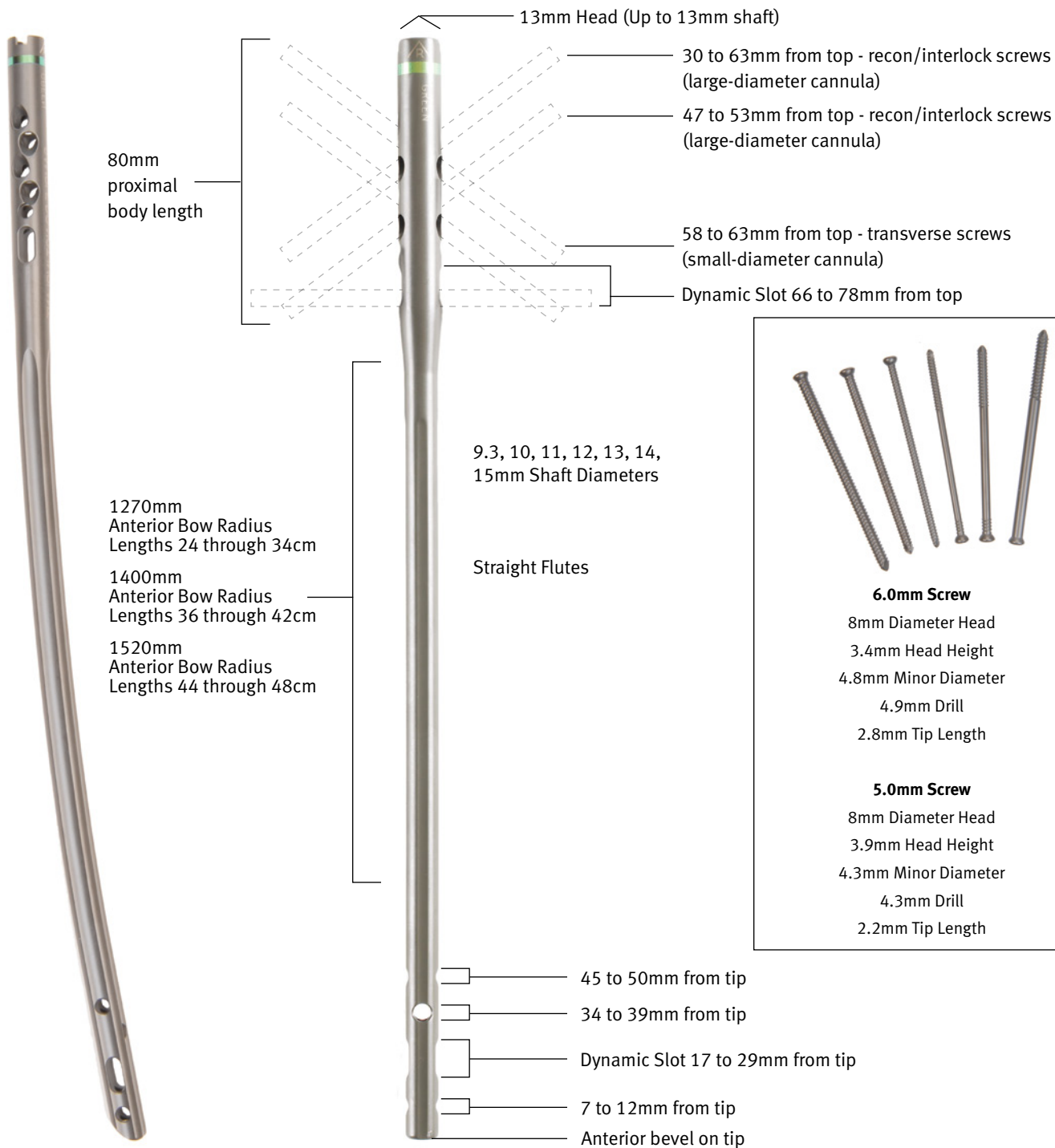

Fig. 31



* It is the responsibility of the surgeon to determine what is the most suitable postoperative care depending on each patient's health condition.

Antegrade Femoral PF Nail Details



Antegrade Femoral GT Nail Details (9.3mm and greater)

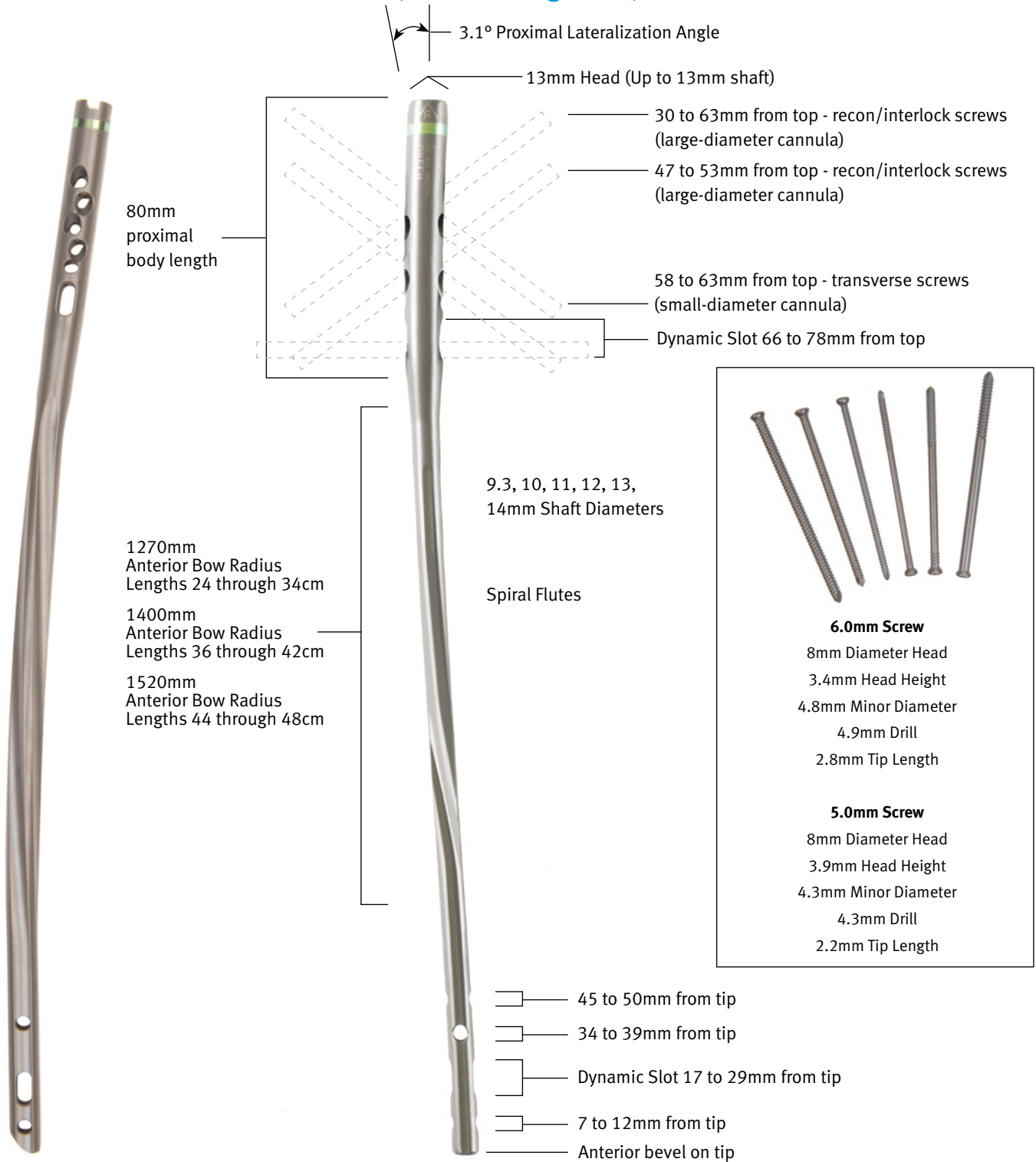

Antegrade Femoral GT 8.3mm Nail Details

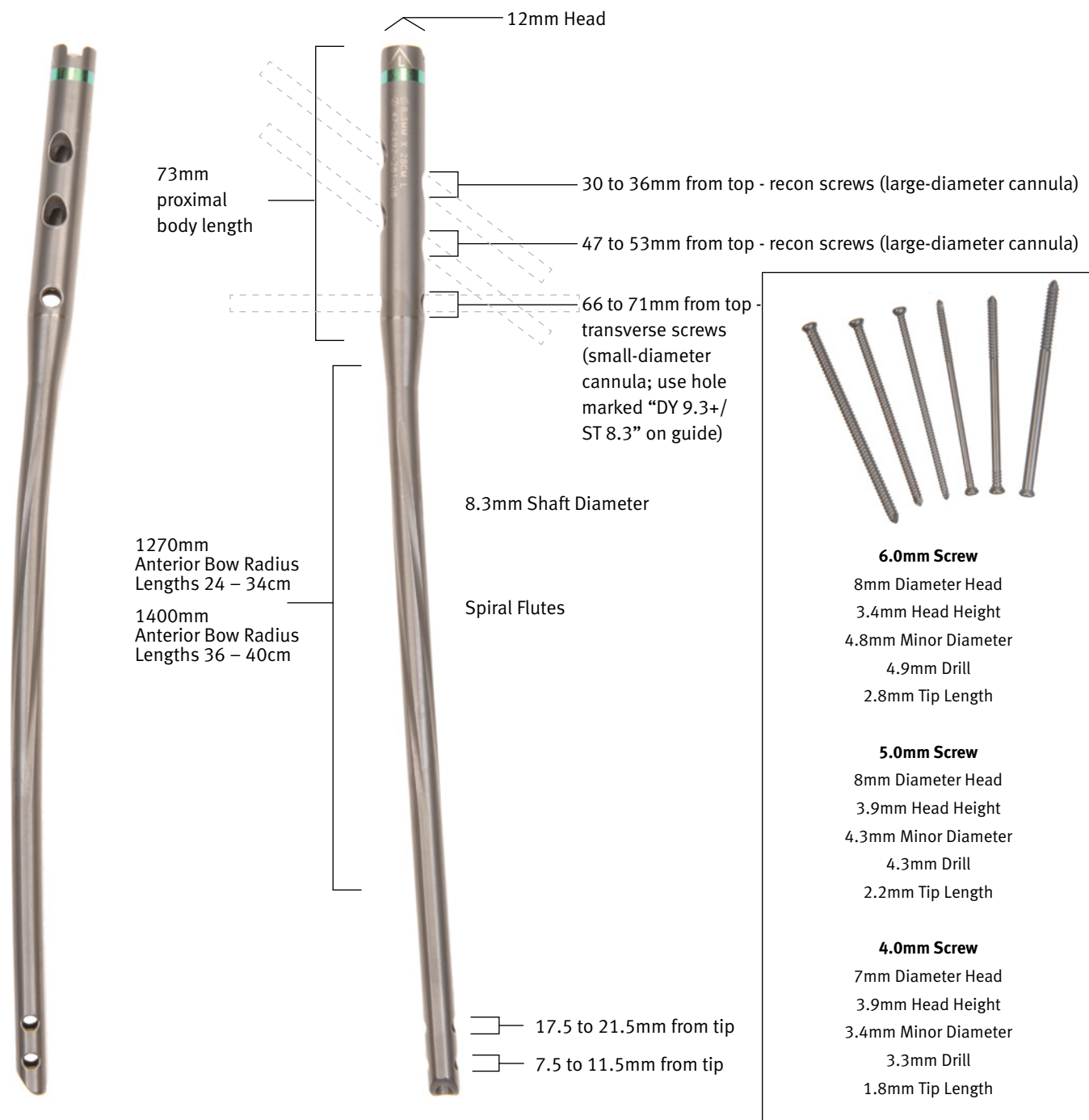

Case Examples



Pre-Op



Post-Op

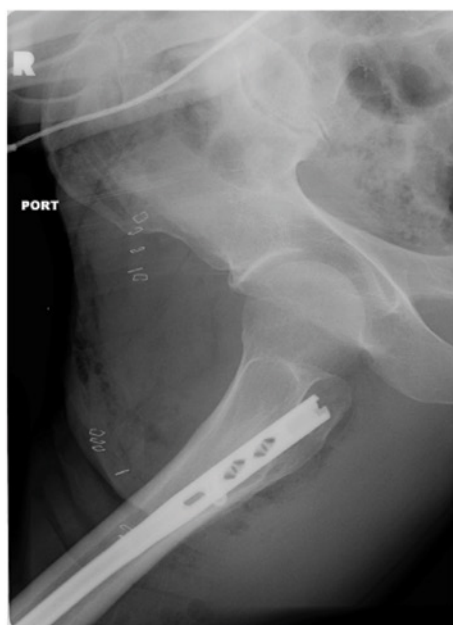

Post-Op

Product Information

Antegrade Femur, Greater Trochanter Nails

Item Number	Product Description	Item Number	Product Description
47-2492-260-08	Antegrade GREATER TROCHANTER Femoral Nail 8.3mm X 26cm Right Ti-6Al-4V	47-2492-380-10	Antegrade GREATER TROCHANTER Femoral Nail 10mm X 38cm Right Ti-6Al-4V
47-2492-280-08	Antegrade GREATER TROCHANTER Femoral Nail 8.3mm X 28cm Right Ti-6Al-4V	47-2492-400-10	Antegrade GREATER TROCHANTER Femoral Nail 10mm X 40cm Right Ti-6Al-4V
47-2492-300-08	Antegrade GREATER TROCHANTER Femoral Nail 8.3mm X 30cm Right Ti-6Al-4V	47-2492-420-10	Antegrade GREATER TROCHANTER Femoral Nail 10mm X 42cm Right Ti-6Al-4V
47-2492-320-08	Antegrade GREATER TROCHANTER Femoral Nail 8.3mm X 32cm Right Ti-6Al-4V	47-2492-440-10	Antegrade GREATER TROCHANTER Femoral Nail 10mm X 44cm Right Ti-6Al-4V
47-2492-340-08	Antegrade GREATER TROCHANTER Femoral Nail 8.3mm X 34cm Right Ti-6Al-4V	47-2492-460-10	Antegrade GREATER TROCHANTER Femoral Nail 10mm X 46cm Right Ti-6Al-4V
47-2492-360-08	Antegrade GREATER TROCHANTER Femoral Nail 8.3mm X 36cm Right Ti-6Al-4V	47-2492-260-11	Antegrade GREATER TROCHANTER Femoral Nail 11mm X 26cm Right Ti-6Al-4V
47-2492-380-08	Antegrade GREATER TROCHANTER Femoral Nail 8.3mm X 38cm Right Ti-6Al-4V	47-2492-280-11	Antegrade GREATER TROCHANTER Femoral Nail 11mm X 28cm Right Ti-6Al-4V
47-2492-400-08	Antegrade GREATER TROCHANTER Femoral Nail 8.3mm X 40cm Right Ti-6Al-4V	47-2492-300-11	Antegrade GREATER TROCHANTER Femoral Nail 11mm X 30cm Right Ti-6Al-4V
47-2492-260-09	Antegrade GREATER TROCHANTER Femoral Nail 9.3mm X 26cm Right Ti-6Al-4V	47-2492-320-11	Antegrade GREATER TROCHANTER Femoral Nail 11mm X 32cm Right Ti-6Al-4V
47-2492-280-09	Antegrade GREATER TROCHANTER Femoral Nail 9.3mm X 28cm Right Ti-6Al-4V	47-2492-340-11	Antegrade GREATER TROCHANTER Femoral Nail 11mm X 34cm Right Ti-6Al-4V
47-2492-300-09	Antegrade GREATER TROCHANTER Femoral Nail 9.3mm X 30cm Right Ti-6Al-4V	47-2492-360-11	Antegrade GREATER TROCHANTER Femoral Nail 11mm X 36cm Right Ti-6Al-4V
47-2492-320-09	Antegrade GREATER TROCHANTER Femoral Nail 9.3mm X 32cm Right Ti-6Al-4V	47-2492-380-11	Antegrade GREATER TROCHANTER Femoral Nail 11mm X 38cm Right Ti-6Al-4V
47-2492-340-09	Antegrade GREATER TROCHANTER Femoral Nail 9.3mm X 34cm Right Ti-6Al-4V	47-2492-400-11	Antegrade GREATER TROCHANTER Femoral Nail 11mm X 40cm Right Ti-6Al-4V
47-2492-360-09	Antegrade GREATER TROCHANTER Femoral Nail 9.3mm X 36cm Right Ti-6Al-4V	47-2492-420-11	Antegrade GREATER TROCHANTER Femoral Nail 11mm X 42cm Right Ti-6Al-4V
47-2492-380-09	Antegrade GREATER TROCHANTER Femoral Nail 9.3mm X 38cm Right Ti-6Al-4V	47-2492-440-11	Antegrade GREATER TROCHANTER Femoral Nail 11mm X 44cm Right Ti-6Al-4V
47-2492-400-09	Antegrade GREATER TROCHANTER Femoral Nail 9.3mm X 40cm Right Ti-6Al-4V	47-2492-460-11	Antegrade GREATER TROCHANTER Femoral Nail 11mm X 46cm Right Ti-6Al-4V
47-2492-420-09	Antegrade GREATER TROCHANTER Femoral Nail 9.3mm X 42cm Right Ti-6Al-4V	47-2492-260-12	Antegrade GREATER TROCHANTER Femoral Nail 12mm X 26cm Right Ti-6Al-4V
47-2492-440-09	Antegrade GREATER TROCHANTER Femoral Nail 9.3mm X 44cm Right Ti-6Al-4V	47-2492-280-12	Antegrade GREATER TROCHANTER Femoral Nail 12mm X 28cm Right Ti-6Al-4V
47-2492-460-09	Antegrade GREATER TROCHANTER Femoral Nail 9.3mm X 46cm Right Ti-6Al-4V	47-2492-300-12	Antegrade GREATER TROCHANTER Femoral Nail 12mm X 30cm Right Ti-6Al-4V
47-2492-260-10	Antegrade GREATER TROCHANTER Femoral Nail 10mm X 26cm Right Ti-6Al-4V	47-2492-320-12	Antegrade GREATER TROCHANTER Femoral Nail 12mm X 32cm Right Ti-6Al-4V
47-2492-280-10	Antegrade GREATER TROCHANTER Femoral Nail 10mm X 28cm Right Ti-6Al-4V	47-2492-340-12	Antegrade GREATER TROCHANTER Femoral Nail 12mm X 34cm Right Ti-6Al-4V
47-2492-300-10	Antegrade GREATER TROCHANTER Femoral Nail 10mm X 30cm Right Ti-6Al-4V	47-2492-360-12	Antegrade GREATER TROCHANTER Femoral Nail 12mm X 36cm Right Ti-6Al-4V
47-2492-320-10	Antegrade GREATER TROCHANTER Femoral Nail 10mm X 32cm Right Ti-6Al-4V	47-2492-380-12	Antegrade GREATER TROCHANTER Femoral Nail 12mm X 38cm Right Ti-6Al-4V
47-2492-340-10	Antegrade GREATER TROCHANTER Femoral Nail 10mm X 34cm Right Ti-6Al-4V	47-2492-400-12	Antegrade GREATER TROCHANTER Femoral Nail 12mm X 40cm Right Ti-6Al-4V
47-2492-360-10	Antegrade GREATER TROCHANTER Femoral Nail 10mm X 36cm Right Ti-6Al-4V	47-2492-420-12	Antegrade GREATER TROCHANTER Femoral Nail 12mm X 42cm Right Ti-6Al-4V

6.0mm Partially Threaded Screws (for proximal recon holes)

Item Number	Product Description
47-2483-050-60	6.0mm Cancellous Screw 50mm Length Ti-6Al-4V Partially Threaded 3.5mm Hex Head
47-2483-055-60	6.0mm Cancellous Screw 55mm Length Ti-6Al-4V Partially Threaded 3.5mm Hex Head
47-2483-060-60	6.0mm Cancellous Screw 60mm Length Ti-6Al-4V Partially Threaded 3.5mm Hex Head
47-2483-065-60	6.0mm Cancellous Screw 65mm Length Ti-6Al-4V Partially Threaded 3.5mm Hex Head
47-2483-070-60	6.0mm Cancellous Screw 70mm Length Ti-6Al-4V Partially Threaded 3.5mm Hex Head
47-2483-075-60	6.0mm Cancellous Screw 75mm Length Ti-6Al-4V Partially Threaded 3.5mm Hex Head
47-2483-080-60	6.0mm Cancellous Screw 80mm Length Ti-6Al-4V Partially Threaded 3.5mm Hex Head
47-2483-085-60	6.0mm Cancellous Screw 85mm Length Ti-6Al-4V Partially Threaded 3.5mm Hex Head
47-2483-090-60	6.0mm Cancellous Screw 90mm Length Ti-6Al-4V Partially Threaded 3.5mm Hex Head
47-2483-095-60	6.0mm Cancellous Screw 95mm Length Ti-6Al-4V Partially Threaded 3.5mm Hex Head
47-2483-100-60	6.0mm Cancellous Screw 100mm Length Ti-6Al-4V Partially Threaded 3.5mm Hex Head
47-2483-105-60	6.0mm Cancellous Screw 105mm Length Ti-6Al-4V Partially Threaded 3.5mm Hex Head
47-2483-110-60	6.0mm Cancellous Screw 110mm Length Ti-6Al-4V Partially Threaded 3.5mm Hex Head
47-2483-115-60	6.0mm Cancellous Screw 115mm Length Ti-6Al-4V Partially Threaded 3.5mm Hex Head
47-2483-120-60	6.0mm Cancellous Screw 120mm Length Ti-6Al-4V Partially Threaded 3.5mm Hex Head
47-2483-125-60	6.0mm Cancellous Screw 125mm Length Ti-6Al-4V Partially Threaded 3.5mm Hex Head
47-2483-130-60	6.0mm Cancellous Screw 130mm Length Ti-6Al-4V Partially Threaded 3.5mm Hex Head
47-2483-135-60	6.0mm Cancellous Screw 135mm Length Ti-6Al-4V Partially Threaded 3.5mm Hex Head
47-2483-140-60	6.0mm Cancellous Screw 140mm Length Ti-6Al-4V Partially Threaded 3.5mm Hex Head

6.0mm Fixed Angle Screws (for descending interlocking holes)

Item Number	Product Description
47-2484-050-60	6.0mm Cancellous Screw 50mm Length Ti-6Al-4V Fixed Angle 3.5mm Hex Head
47-2484-055-60	6.0mm Cancellous Screw 55mm Length Ti-6Al-4V Fixed Angle 3.5mm Hex Head
47-2484-060-60	6.0mm Cancellous Screw 60mm Length Ti-6Al-4V Fixed Angle 3.5mm Hex Head
47-2484-065-60	6.0mm Cancellous Screw 65mm Length Ti-6Al-4V Fixed Angle 3.5mm Hex Head
47-2484-070-60	6.0mm Cancellous Screw 70mm Length Ti-6Al-4V Fixed Angle 3.5mm Hex Head
47-2484-075-60	6.0mm Cancellous Screw 75mm Length Ti-6Al-4V Fixed Angle 3.5mm Hex Head
47-2484-080-60	6.0mm Cancellous Screw 80mm Length Ti-6Al-4V Fixed Angle 3.5mm Hex Head
47-2484-085-60	6.0mm Cancellous Screw 85mm Length Ti-6Al-4V Fixed Angle 3.5mm Hex Head
47-2484-090-60	6.0mm Cancellous Screw 90mm Length Ti-6Al-4V Fixed Angle 3.5mm Hex Head
47-2484-095-60	6.0mm Cancellous Screw 95mm Length Ti-6Al-4V Fixed Angle 3.5mm Hex Head
47-2484-100-60	6.0mm Cancellous Screw 100mm Length Ti-6Al-4V Fixed Angle 3.5mm Hex Head
47-2484-105-60	6.0mm Cancellous Screw 105mm Length Ti-6Al-4V Fixed Angle 3.5mm Hex Head
47-2484-110-60	6.0mm Cancellous Screw 110mm Length Ti-6Al-4V Fixed Angle 3.5mm Hex Head
47-2484-115-60	6.0mm Cancellous Screw 115mm Length Ti-6Al-4V Fixed Angle 3.5mm Hex Head
47-2484-120-60	6.0mm Cancellous Screw 120mm Length Ti-6Al-4V Fixed Angle 3.5mm Hex Head
47-2484-125-60	6.0mm Cancellous Screw 125mm Length Ti-6Al-4V Fixed Angle 3.5mm Hex Head
47-2484-130-60	6.0mm Cancellous Screw 130mm Length Ti-6Al-4V Fixed Angle 3.5mm Hex Head
47-2484-135-60	6.0mm Cancellous Screw 135mm Length Ti-6Al-4V Fixed Angle 3.5mm Hex Head
47-2484-140-60	6.0mm Cancellous Screw 140mm Length Ti-6Al-4V Fixed Angle 3.5mm Hex Head

5.0mm Partially Threaded Screws (for proximal transverse screw holes and distal screw holes in 9.3mm and larger diameter nails)

Item Number	Product Description
47-2483-020-50	5.0mm Cortical Screw 20mm Length Ti-6Al-4V Partially Threaded 3.5mm Hex Head
47-2483-022-50	5.0mm Cortical Screw 22.5mm Length Ti-6Al-4V Partially Threaded 3.5mm Hex Head
47-2483-025-50	5.0mm Cortical Screw 25mm Length Ti-6Al-4V Partially Threaded 3.5mm Hex Head
47-2483-027-50	5.0mm Cortical Screw 27.5mm Length Ti-6Al-4V Partially Threaded 3.5mm Hex Head
47-2483-030-50	5.0mm Cortical Screw 30mm Length Ti-6Al-4V Partially Threaded 3.5mm Hex Head
47-2483-032-50	5.0mm Cortical Screw 32.5mm Length Ti-6Al-4V Partially Threaded 3.5mm Hex Head
47-2483-035-50	5.0mm Cortical Screw 35mm Length Ti-6Al-4V Partially Threaded 3.5mm Hex Head
47-2483-037-50	5.0mm Cortical Screw 37.5mm Length Ti-6Al-4V Partially Threaded 3.5mm Hex Head
47-2483-040-50	5.0mm Cortical Screw 40mm Length Ti-6Al-4V Partially Threaded 3.5mm Hex Head
47-2483-042-50	5.0mm Cortical Screw 42.5mm Length Ti-6Al-4V Partially Threaded 3.5mm Hex Head
47-2483-045-50	5.0mm Cortical Screw 45mm Length Ti-6Al-4V Partially Threaded 3.5mm Hex Head
47-2483-047-50	5.0mm Cortical Screw 47.5mm Length Ti-6Al-4V Partially Threaded 3.5mm Hex Head
47-2483-050-50	5.0mm Cortical Screw 50mm Length Ti-6Al-4V Partially Threaded 3.5mm Hex Head
47-2483-052-50	5.0mm Cortical Screw 52.5mm Length Ti-6Al-4V Partially Threaded 3.5mm Hex Head
47-2483-055-50	5.0mm Cortical Screw 55mm Length Ti-6Al-4V Partially Threaded 3.5mm Hex Head
47-2483-057-50	5.0mm Cortical Screw 57.5mm Length Ti-6Al-4V Partially Threaded 3.5mm Hex Head
47-2483-060-50	5.0mm Cortical Screw 60mm Length Ti-6Al-4V Partially Threaded 3.5mm Hex Head
47-2483-065-50	5.0mm Cortical Screw 65mm Length Ti-6Al-4V Partially Threaded 3.5mm Hex Head
47-2483-070-50	5.0mm Cortical Screw 70mm Length Ti-6Al-4V Partially Threaded 3.5mm Hex Head
47-2483-075-50	5.0mm Cortical Screw 75mm Length Ti-6Al-4V Partially Threaded 3.5mm Hex Head
47-2483-080-50	5.0mm Cortical Screw 80mm Length Ti-6Al-4V Partially Threaded 3.5mm Hex Head
47-2483-085-50	5.0mm Cortical Screw 85mm Length Ti-6Al-4V Partially Threaded 3.5mm Hex Head
47-2483-090-50	5.0mm Cortical Screw 90mm Length Ti-6Al-4V Partially Threaded 3.5mm Hex Head
47-2483-095-50	5.0mm Cortical Screw 95mm Length Ti-6Al-4V Partially Threaded 3.5mm Hex Head
47-2483-100-50	5.0mm Cortical Screw 100mm Length Ti-6Al-4V Partially Threaded 3.5mm Hex Head

5.0mm Fixed Angle Screws (for proximal transverse screw holes and distal screw holes in 9.3mm and larger diameter nails)

Item Number	Product Description
47-2484-020-50	5.0mm Cortical Screw 20mm Length Ti-6Al-4V Fixed Angle 3.5mm Hex Head
47-2484-022-50	5.0mm Cortical Screw 22.5mm Length Ti-6Al-4V Fixed Angle 3.5mm Hex Head
47-2484-025-50	5.0mm Cortical Screw 25mm Length Ti-6Al-4V Fixed Angle 3.5mm Hex Head
47-2484-027-50	5.0mm Cortical Screw 27.5mm Length Ti-6Al-4V Fixed Angle 3.5mm Hex Head
47-2484-030-50	5.0mm Cortical Screw 30mm Length Ti-6Al-4V Fixed Angle 3.5mm Hex Head
47-2484-032-50	5.0mm Cortical Screw 32.5mm Length Ti-6Al-4V Fixed Angle 3.5mm Hex Head
47-2484-035-50	5.0mm Cortical Screw 35mm Length Ti-6Al-4V Fixed Angle 3.5mm Hex Head
47-2484-037-50	5.0mm Cortical Screw 37.5mm Length Ti-6Al-4V Fixed Angle 3.5mm Hex Head
47-2484-040-50	5.0mm Cortical Screw 40mm Length Ti-6Al-4V Fixed Angle 3.5mm Hex Head
47-2484-042-50	5.0mm Cortical Screw 42.5mm Length Ti-6Al-4V Fixed Angle 3.5mm Hex Head
47-2484-045-50	5.0mm Cortical Screw 45mm Length Ti-6Al-4V Fixed Angle 3.5mm Hex Head
47-2484-047-50	5.0mm Cortical Screw 47.5mm Length Ti-6Al-4V Fixed Angle 3.5mm Hex Head
47-2484-050-50	5.0mm Cortical Screw 50mm Length Ti-6Al-4V Fixed Angle 3.5mm Hex Head
47-2484-052-50	5.0mm Cortical Screw 52.5mm Length Ti-6Al-4V Fixed Angle 3.5mm Hex Head
47-2484-055-50	5.0mm Cortical Screw 55mm Length Ti-6Al-4V Fixed Angle 3.5mm Hex Head
47-2484-057-50	5.0mm Cortical Screw 57.5mm Length Ti-6Al-4V Fixed Angle 3.5mm Hex Head
47-2484-060-50	5.0mm Cortical Screw 60mm Length Ti-6Al-4V Fixed Angle 3.5mm Hex Head
47-2484-065-50	5.0mm Cortical Screw 65mm Length Ti-6Al-4V Fixed Angle 3.5mm Hex Head
47-2484-070-50	5.0mm Cortical Screw 70mm Length Ti-6Al-4V Fixed Angle 3.5mm Hex Head
47-2484-075-50	5.0mm Cortical Screw 75mm Length Ti-6Al-4V Fixed Angle 3.5mm Hex Head
47-2484-080-50	5.0mm Cortical Screw 80mm Length Ti-6Al-4V Fixed Angle 3.5mm Hex Head
47-2484-085-50	5.0mm Cortical Screw 85mm Length Ti-6Al-4V Fixed Angle 3.5mm Hex Head
47-2484-090-50	5.0mm Cortical Screw 90mm Length Ti-6Al-4V Fixed Angle 3.5mm Hex Head
47-2484-095-50	5.0mm Cortical Screw 95mm Length Ti-6Al-4V Fixed Angle 3.5mm Hex Head
47-2484-100-50	5.0mm Cortical Screw 100mm Length Ti-6Al-4V Fixed Angle 3.5mm Hex Head

4.0mm Partially Threaded Screws

(for distal screw holes in 8.3mm Greater Trochanter Entry Point nails only)

Item Number	Product Description
47-2483-020-40	4.0mm Cortical Screw 20mm Length Ti-6Al-4V Partially Threaded 3.5mm Hex Head
47-2483-022-40	4.0mm Cortical Screw 22.5mm Length Ti-6Al-4V Partially Threaded 3.5mm Hex Head
47-2483-025-40	4.0mm Cortical Screw 25mm Length Ti-6Al-4V Partially Threaded 3.5mm Hex Head
47-2483-027-40	4.0mm Cortical Screw 27.5mm Length Ti-6Al-4V Partially Threaded 3.5mm Hex Head
47-2483-030-40	4.0mm Cortical Screw 30mm Length Ti-6Al-4V Partially Threaded 3.5mm Hex Head
47-2483-032-40	4.0mm Cortical Screw 32.5mm Length Ti-6Al-4V Partially Threaded 3.5mm Hex Head
47-2483-035-40	4.0mm Cortical Screw 35mm Length Ti-6Al-4V Partially Threaded 3.5mm Hex Head
47-2483-037-40	4.0mm Cortical Screw 37.5mm Length Ti-6Al-4V Partially Threaded 3.5mm Hex Head
47-2483-040-40	4.0mm Cortical Screw 40mm Length Ti-6Al-4V Partially Threaded 3.5mm Hex Head
47-2483-042-40	4.0mm Cortical Screw 42.5mm Length Ti-6Al-4V Partially Threaded 3.5mm Hex Head
47-2483-045-40	4.0mm Cortical Screw 45mm Length Ti-6Al-4V Partially Threaded 3.5mm Hex Head
47-2483-047-40	4.0mm Cortical Screw 47.5mm Length Ti-6Al-4V Partially Threaded 3.5mm Hex Head
47-2483-050-40	4.0mm Cortical Screw 50mm Length Ti-6Al-4V Partially Threaded 3.5mm Hex Head
47-2483-052-40	4.0mm Cortical Screw 52.5mm Length Ti-6Al-4V Partially Threaded 3.5mm Hex Head
47-2483-055-40	4.0mm Cortical Screw 55mm Length Ti-6Al-4V Partially Threaded 3.5mm Hex Head
47-2483-057-40	4.0mm Cortical Screw 57.5mm Length Ti-6Al-4V Partially Threaded 3.5mm Hex Head
47-2483-060-40	4.0mm Cortical Screw 60mm Length Ti-6Al-4V Partially Threaded 3.5mm Hex Head
47-2483-065-40	4.0mm Cortical Screw 65mm Length Ti-6Al-4V Partially Threaded 3.5mm Hex Head
47-2483-070-40	4.0mm Cortical Screw 70mm Length Ti-6Al-4V Partially Threaded 3.5mm Hex Head
47-2483-075-40	4.0mm Cortical Screw 75mm Length Ti-6Al-4V Partially Threaded 3.5mm Hex Head
47-2483-080-40	4.0mm Cortical Screw 80mm Length Ti-6Al-4V Partially Threaded 3.5mm Hex Head
47-2483-085-40	4.0mm Cortical Screw 85mm Length Ti-6Al-4V Partially Threaded 3.5mm Hex Head
47-2483-090-40	4.0mm Cortical Screw 90mm Length Ti-6Al-4V Partially Threaded 3.5mm Hex Head
47-2483-095-40	4.0mm Cortical Screw 95mm Length Ti-6Al-4V Partially Threaded 3.5mm Hex Head
47-2483-100-40	4.0mm Cortical Screw 100mm Length Ti-6Al-4V Partially Threaded 3.5mm Hex Head

4.0mm Fixed Angled Screws

(for distal screw holes in 8.3mm Greater Trochanter Entry Point nails only)

Item Number	Product Description
47-2484-020-40	4.0mm Cortical Screw 20mm Length Ti-6Al-4V Fixed Angle 3.5mm Hex Head
47-2484-022-40	4.0mm Cortical Screw 22.5mm Length Ti-6Al-4V Fixed Angle 3.5mm Hex Head
47-2484-025-40	4.0mm Cortical Screw 25mm Length Ti-6Al-4V Fixed Angle 3.5mm Hex Head
47-2484-027-40	4.0mm Cortical Screw 27.5mm Length Ti-6Al-4V Fixed Angle 3.5mm Hex Head
47-2484-030-40	4.0mm Cortical Screw 30mm Length Ti-6Al-4V Fixed Angle 3.5mm Hex Head
47-2484-032-40	4.0mm Cortical Screw 32.5mm Length Ti-6Al-4V Fixed Angle 3.5mm Hex Head
47-2484-035-40	4.0mm Cortical Screw 35mm Length Ti-6Al-4V Fixed Angle 3.5mm Hex Head
47-2484-037-40	4.0mm Cortical Screw 37.5mm Length Ti-6Al-4V Fixed Angle 3.5mm Hex Head
47-2484-040-40	4.0mm Cortical Screw 40mm Length Ti-6Al-4V Fixed Angle 3.5mm Hex Head
47-2484-042-40	4.0mm Cortical Screw 42.5mm Length Ti-6Al-4V Fixed Angle 3.5mm Hex Head
47-2484-045-40	4.0mm Cortical Screw 45mm Length Ti-6Al-4V Fixed Angle 3.5mm Hex Head
47-2484-047-40	4.0mm Cortical Screw 47.5mm Length Ti-6Al-4V Fixed Angle 3.5mm Hex Head
47-2484-050-40	4.0mm Cortical Screw 50mm Length Ti-6Al-4V Fixed Angle 3.5mm Hex Head
47-2484-052-40	4.0mm Cortical Screw 52.5mm Length Ti-6Al-4V Fixed Angle 3.5mm Hex Head
47-2484-055-40	4.0mm Cortical Screw 55mm Length Ti-6Al-4V Fixed Angle 3.5mm Hex Head
47-2484-057-40	4.0mm Cortical Screw 57.5mm Length Ti-6Al-4V Fixed Angle 3.5mm Hex Head
47-2484-060-40	4.0mm Cortical Screw 60mm Length Ti-6Al-4V Fixed Angle 3.5mm Hex Head
47-2484-065-40	4.0mm Cortical Screw 65mm Length Ti-6Al-4V Fixed Angle 3.5mm Hex Head
47-2484-070-40	4.0mm Cortical Screw 70mm Length Ti-6Al-4V Fixed Angle 3.5mm Hex Head
47-2484-075-40	4.0mm Cortical Screw 75mm Length Ti-6Al-4V Fixed Angle 3.5mm Hex Head
47-2484-080-40	4.0mm Cortical Screw 80mm Length Ti-6Al-4V Fixed Angle 3.5mm Hex Head
47-2484-085-40	4.0mm Cortical Screw 85mm Length Ti-6Al-4V Fixed Angle 3.5mm Hex Head
47-2484-090-40	4.0mm Cortical Screw 90mm Length Ti-6Al-4V Fixed Angle 3.5mm Hex Head
47-2484-095-40	4.0mm Cortical Screw 95mm Length Ti-6Al-4V Fixed Angle 3.5mm Hex Head
47-2484-100-40	4.0mm Cortical Screw 100mm Length Ti-6Al-4V Fixed Angle 3.5mm Hex Head

Nail Caps

Item Number	Product Description
47-2487-001-00	Femoral Nail Cap 0mm Height Ti-6Al-4V
47-2487-001-05	Femoral Nail Cap 5mm Height Ti-6Al-4V
47-2487-001-10	Femoral Nail Cap 10mm Height Ti-6Al-4V
47-2487-001-15	Femoral Nail Cap 15mm Height Ti-6Al-4V

Instruments**KT-2490-001-02 Small Antegrade Femoral Instrument Set**

Item Number	Product Description	
00-2490-046-30	3.0mm Threaded Pin	3
00-2490-008-01	Small Antegrade Femoral Connecting Bolt	2
00-2490-031-05	11mm Hex / Pin Wrench	2
00-2490-046-20	2.0mm Pin	2
00-2490-061-80	Short Screw Cannula 10.0mm OD 8.0mm ID	1
00-2490-081-80	Short Screw Cannula 12.5mm OD 8.0mm ID	1
00-2490-082-80	Short Screw Trocar 8.0mm	2
00-2490-063-30	Short Guide Pin Sleeve 3.0mm	2
00-2490-000-15	Connecting Knob Radel Bushing	1
00-2490-000-30	Nail Diameter Gauge	1
00-2490-000-33	Ruler	1
00-2490-000-34	Nail Length Gauge	1
00-2490-098-10	Small Antegrade Femur Targeting Guide Handle	1
00-2490-091-15	Small Antegrade Femur Interlock Module - Solid	1
00-2490-091-16	Small Antegrade Femur Recon Screw Module - Solid	1
00-2490-010-01	Short Cannulated Awl	1
00-2490-012-00	Guide Wire Gripper	1
00-2490-013-00	Entry Cannula	1
00-2490-013-01	Entry Cannula Starting Point Locator	1
00-2490-014-01	Inner Channel Reamer	1
00-2490-014-02	Channel Reamer Sleeve 14.5mm	1
00-2490-014-14	Taper Reamer 14.5mm	1
00-2490-014-80	Entry Reamer 8.0mm	1
00-2490-017-00	Guide Wire Pusher	1
00-2490-031-00	Connecting Bolt Inserter	1
00-2490-032-00	Impaction Head	1
00-2490-032-01	Slotted Mallet	1
00-2490-035-75	Freehand Mod 3.5mm Hex Screwdriver	2
00-2490-046-32	Guide Pin Inserter/Extractor	1
00-2490-047-80	Long Cannulated Depth Gauge	1
00-2490-050-02	Modular T-Handle	1
00-2490-065-80	Short Screw Depth Gauge 8.0mm	1
00-2490-070-00	Freehand Targeting Wand	1
00-2490-073-00	Freehand Targeting Depth Gauge	1
00-2490-074-00	Freehand Tissue Protection Sleeve	1
00-2490-080-00	Nail Cap Inserter	1
02.00020.049	Ratchet Wrench 11	1

00-2490-035-60	Short Modular 3.5mm Hex Screwdriver	2
00-2490-035-62	Captured Screwdriver 3.5 Hex - Short	1
00-2490-035-72	Captured Screwdriver 3.5 Hex - Freehand	1
00-2490-080-03	Nail Cap Retaining Shaft	1
00-2490-033-00	Slap Hammer Adapter	1
00-2490-090-00	Cann Extract Adapter 5/16"	1
00-2490-000-41	Hole Indicator	2
00-2490-050-00	Modular T-Handle AO	1
00-2490-063-43	Short Drill Sleeve 4.3mm	2
00-2490-063-49	Short Drill Sleeve 4.9mm	2
00-2490-064-43	Calibrated Drill 4.3mm Short	2
00-2490-064-49	Short Calibrated Drill 4.9mm	2
00-2490-064-50	Short Calibrated Cannulated 4.9mm Drill	1
00-2490-075-33	3.3mm Freehand Drill 152.5mm	2
00-2490-075-43	4.3mm Freehand Drill 152.5mm	2
00-2490-012-30	3.0mm Threaded Pin by 305mm	3
00-2490-024-00	Reduction Finger	1
00-2490-000-14	Connecting Knob	3
00-5900-099-00	Standard Lids	2

Instrument Cases

(Select both "Stainless Steel" or both "Stainless Steel and Aluminum" Cases)

Item Number	Product Description
00-2490-082-00	Antegrade Femur Case 1 of 2 – Stainless Steel
00-2490-085-00	Antegrade Femur Case 2 of 2 – Stainless Steel
00-2490-082-50	Antegrade Femur Case 1 of 2 – Stainless Steel and Aluminum (Blue)
00-2490-085-50	Antegrade Femur Case 2 of 2 – Stainless Steel and Aluminum (Blue)

Optional Instruments

Item Number	Product Description
00-2490-060-50	Short 5.0mm Tap

Ball Tip Guide Wire (available separately)

Item Number	Product Description
00-2255-008-01	3.0mm x 100cm Ball Tip Guide Wire (Non-Sterile)
47-2255-008-01	3.0mm x 100cm Ball Tip Guide Wire (Sterile)

Tear Drop Guide Wire (available separately)

Item Number	Product Description
47-2490-097-00	3.0mm x 100cm Tear Drop Guide Wire (Sterile)
47-2490-097-01	2.4mm x 100cm Tear Drop Guide Wire (Sterile)



DISCLAIMER:

This documentation is intended exclusively for physicians and is not intended for laypersons. Information on the products and procedures contained in this document is of a general nature and does not represent and does not constitute medical advice or recommendations. Because this information does not purport to constitute any diagnostic or therapeutic statement with regard to any individual medical case, each patient must be examined and advised individually, and this document does not replace the need for such examination and/or advise in whole or in part.

Please refer to the package inserts for important product information, including, but not limited to, indications, contraindications, warnings, precautions, and adverse effects.

Contact your Zimmer representative or visit us at www.zimmer.com

The CE mark is valid only if it is also printed on the product label.

